

Item Description e12-12-150-0969-1-200-0.22-SI-FPT-2.0-HT-VBG
 Model e12.1500969200

ECCN: 6A005.d.1.b.1⁴

	Units	Lower Spec	Typical	Upper Spec
Optical				
CW Output Power (in fiber)	W		150	
CW Output Power (as measured)	W	130	145	
Wavelength Peak	nm	968.0	969.0	970.0
Spectral Width (FWHM)	nm			1.0
NA within 95% Power Enclosure	-		0.18	
Fiber Core / Clad Diameter	µm		200 / 220	
Fiber NA / Index Type	-		0.22 NA / Step Index	
Back Reflection Isolation 1060 - 1200nm	dB	15		
Electrical				
Electrical-to-Optical Efficiency	%		50	
Threshold Current	A		0.6	
Operating Current	A		16.0	16.0
Operating Voltage	V		18.7	19.2
Wavelength Stabilized Operating Current ⁵	A	10		18
Mechanical				
Mass	g		440	
Fiber Length	m	1.5	2.0	
Active Fiber Bend Radius	mm	35		
Fiber Jacketing	-		900 µm Hytrel Loose Tube Buffer	
Fiber Termination	-		FPT	
Thermal				
Waste Heat	W		149	
Operating (Housing) Temperature ^{2,3}	°C		+30	
Wavelength Temperature Coefficient	nm / °C		0.01	

Outline Drawing (Package Dimension 80 x 76 x 15 mm)

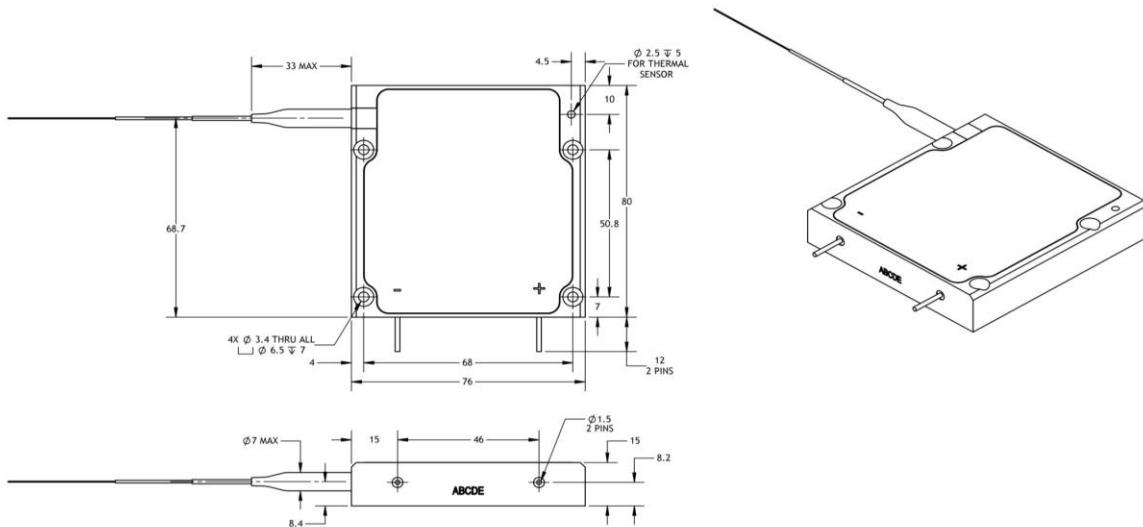

Notes

- 1 Production specification shown are for beginning of life performance. End of life operating current (Iop) is 110% beginning of life Iop.
- 2 A non-condensing environment is required for operation and storage. Storage conditions are from -20 to +70 °C with relative humidity between 5 to 85 %.
- 3 Operating temperature defined by the package housing.
- 4 Export Control Classification Number (ECCN) as defined by the Export Administration Regulations (EAR).
- 5 Wavelength stabilized to >95 % power in band of 967.5 nm to 970.5 nm at the rated operating temperature.

This product is not certified in accordance with IEC 60825-1 or 21CFR1040.10/ 21CFR1040.11 and is solely intended to be integrated into a laser product certified by the Purchaser. The Purchaser acknowledges that their product (incorporating the nLIGHT laser product) must comply with the applicable regulations before it can be sold.



Notice
 nLIGHT continually improves its products to provide customers with outstanding quality and reliability, therefore may change certain specifications and product descriptions at any time, without notice. Additionally, nLIGHT offers a limited warranty to ensure customer satisfaction. For complete details, please contact an nLIGHT sales representative.



nLight Corporation
 5408 NE 88th Street, Bldg E
 Vancouver, Washington 98665
 United States of America
 Phone: 866.202.4488