

Item Description e06-06-070-0915-5-105-0.22-SI-FPT-2.0-HT
Model e06.0700915105

ECCN: EAR99⁴

	Units	Lower Spec	Typical	Upper Spec
Optical				
CW Output Power (in fiber)	W		70	
CW Output Power (as measured)	W	62	68	
Wavelength Centroid	nm	910.0	915.0	920.0
Spectral Width (FWHM)	nm		3.7	7.0
NA within 95% Power Enclosure	-		0.15	
Fiber Core / Clad Diameter	µm		105 / 125	
Fiber NA / Index Type	-		0.22 NA / Step Index	
Back Reflection Isolation 1060 - 1200nm	dB	15		
Electrical				
Electrical-to-Optical Efficiency	%		47	
Threshold Current	A		0.4	
Operating Current	A		14.0	14.0
Operating Voltage	V		10.7	11.6
Mechanical				
Mass	g		85	
Fiber Length	m	1.5	2.0	
Active Fiber Bend Radius	mm	25		
Fiber Jacketing	-		900 um Hytel Loose Tube Buffer	
Fiber Termination	-		FPT	
Thermal				
Waste Heat	W		80	
Operating (Housing) Temperature ^{2,3}	°C		+30	
Wavelength Temperature Coefficient	nm / °C		0.32	
Wavelength Current Coefficient	nm / A		1.1	

Outline Drawing (Package Dimension 46 x 45 x 11.1 mm)

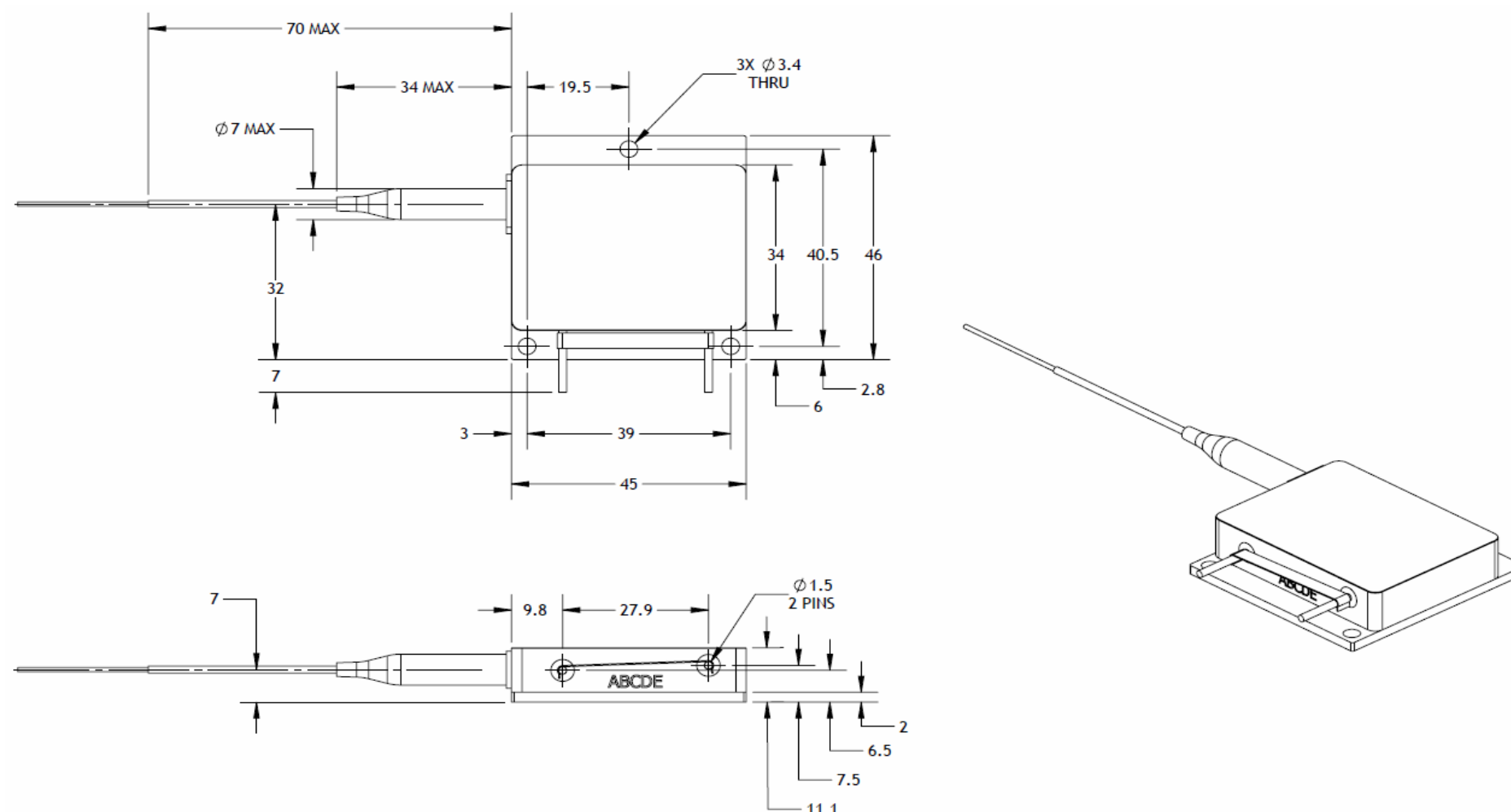

Notes

- ¹ Production specification shown are for beginning of life performance. End of life operating current (Iop) is 110% beginning of life Iop.
- ² A non-condensing environment is required for operation and storage. Storage conditions are from -20 to +70 °C with relative humidity between 5 to 85 %.
- ³ Operating temperature defined by the package housing.
- ⁴ Export Control Classification Number (ECCN) as defined by the Export Administration Regulations (EAR).



This product is not certified in accordance with IEC 60825-1 or 21CFR1040.10/21CFR1040.11 and is solely intended to be integrated into a laser product certified by the Purchaser. The Purchaser acknowledges that their product (incorporating the nLIGHT laser product) must comply with the applicable regulations before it can be sold.



Notice
 nLIGHT continually improves its products to provide customers with outstanding quality and reliability, therefore may change certain specifications and product descriptions at any time, without notice. Additionally, nLIGHT offers a limited warranty to ensure customer satisfaction. For complete details, please contact an nLIGHT sales representative.

nLight Corporation
 5408 NE 88th Street, Bldg E
 Vancouver, Washington 98665
 United States of America
 Phone: 866.202.4488
 360.566.4460