

SLD1190090YY0D5MXXX

Fiber Coupled Superluminescent Diode (SLD)

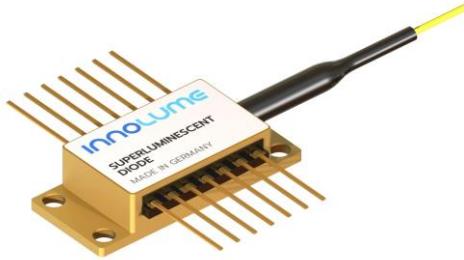

Features:

- Ultra broadband ASE spectra
- Low ripples
- Strong linear polarization
- Individual burn-in and thermal cycling screening
- Proprietary anti-reflection coating technology enabling high reliability
- Polarization maintaining PM980 fiber or HI1060 fiber
- 900um loose tube on fiber (optional)
- Built-in monitor photodiode (optional)

Applications:

- Fiber sensors
- Spectroscopy
- Instrumentation

Recommended Operating Conditions*

@ CW, the case is mounted on room temperature heatsink

Parameter	Min.	Typ.	Max.	Unit
Chip Temperature	20	25	30	°C
Forward Current		315	350	mA
Output Power	0.2	0.5		mW

* - recommended in terms of maximum spectrum width and flatness

Characteristics

@ CW, 25°C, 315mA

Parameter	Min.	Typ.	Max.	Unit
Forward Current @ 0.2mW			350	mA
Forward Voltage		1.4	1.9	V
Mean Wavelength	1180	1190	1200	nm
Bandwidth (FWHM)	75	90		nm
Ripples** (RMS)		0.01	0.1	dB
Excited State Maximum Position		1160		nm
Ground State Maximum Position		1225		nm
Spectrum Dip		5		dB
Polarisation Extinction Ratio (PER)	15	19		dB
Polarisation		TE		

** - RMS in 1nm range around ASE maximum, 20pm resolution

Absolute Maximum Ratings

Parameter	Min	Max	Unit
Output Optical Power		40	mW
Forward Current		800	mA
Reverse Voltage		2	V
TEC Current		3	A
TEC Voltage		4	V
Chip Operating Temperature	5	40	°C
Case Operating Temperature	0	70	°C
Storage Temperature	-40	85	°C
Pin Soldering Temperature (max 10 sec, max case temperature 120°C)		300	°C
Fiber Band Radius	3		cm

Typical Performance (for reference only)

@ CW, the case is mounted on room temperature heatsink

Light-Current-Voltage Characteristics

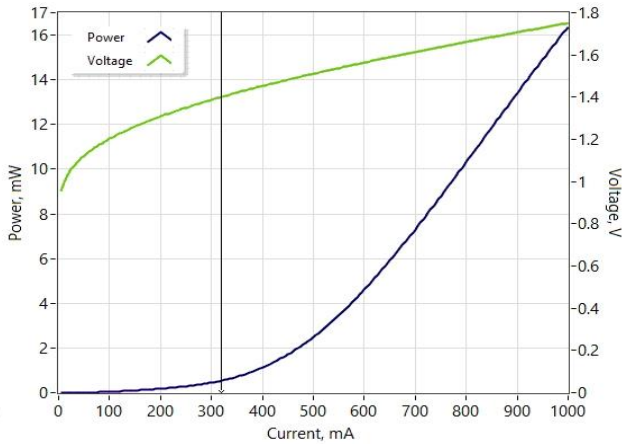

Optical Spectra (res. 1nm)

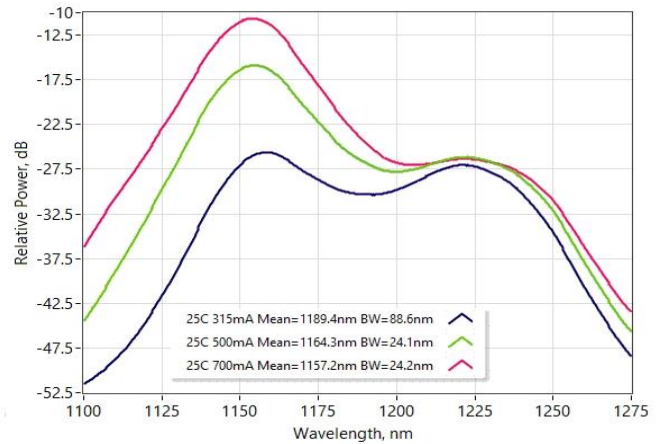

Thermistor specification			Fiber specification			
Parameters	Value	Unit	Parameters	Value	Value	Unit
Type	NTC		Fiber Type	HI1060	PM980	
Resistance @ 25°C	10±0.1	kOhm	Numerical Aperture (Typical)	0.14	0.12	
Beta 25-85°C	3435±1%	K	Cut-off Wavelength	920±50	900±70	nm
			Mode-Field Diameter	6.2±0.3 @1060nm	6.6±0.3 @1060nm	µm
			Cladding Diameter	125±1	125±1	µm
			Coating Diameter	245±15	245±15	µm
			Loose Tube Diameter (optional)	900	900	µm
			Connector	FC/APC	FC/APC	
			Key	narrow	narrow	

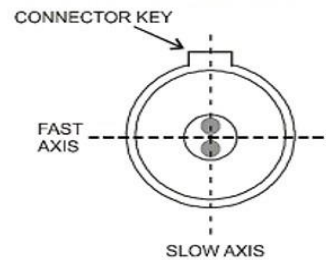
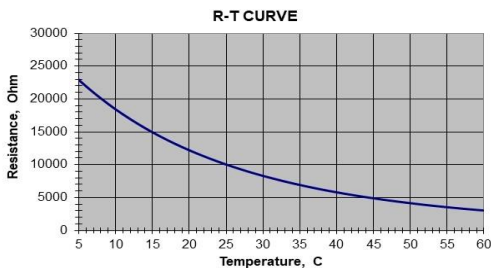

The output light is polarized along the slow axis of PM fiber.

Dimensions (in mm)

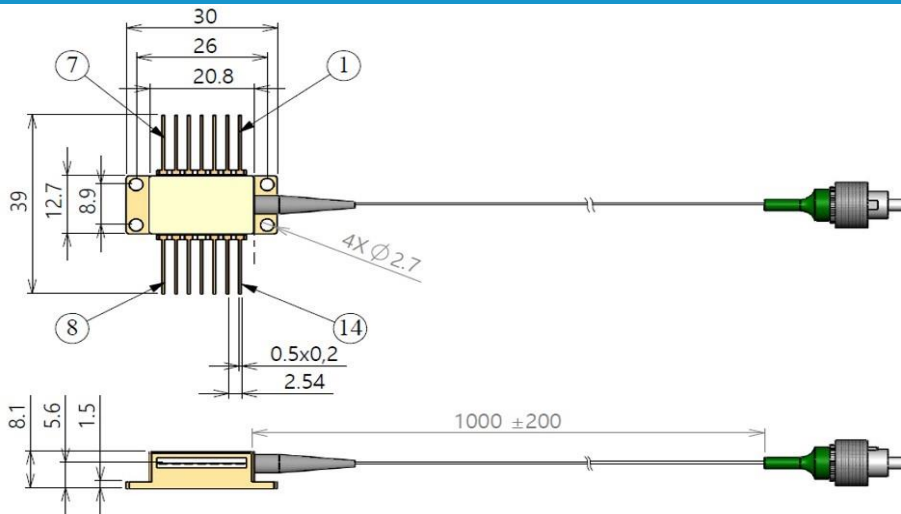

Pin identification:

1. TEC "+"
2. Thermistor
3. Monitor PD anode (Bias "-")
4. Monitor PD cathode (Bias "+")
5. Thermistor
6. -
7. -
8. -
9. -
10. LD anode ("+")
11. LD cathode ("-")
12. -
13. Case
14. TEC "-"

Safety and Operating Instructions

The light emitted from this device is invisible and can be harmful to the human eye. Avoid looking directly into the fiber connector when the device is in operation. Proper laser safety eyewear must be worn during operation with open connector. Absolute Maximum Ratings may be applied to the device for short period of time only. Exposure to maximum ratings for extended period of time or exposure to more than one maximum rating may cause damage or affect the reliability of the device. Operating the device outside of its maximum ratings may cause device failure or a safety hazard. Power supplies used with the component must be employed such that the maximum forward current cannot be exceeded.

A proper heatsink for the device on thermal radiator is required. The device must be mounted on radiator with 4 screws (bolt down in X-style fashion with initial torque set to 0.075Nm and final X-style bolt down at 0.15Nm) or with clamps. The deviation from flatness of radiator surface must be less than 0.05mm. It's recommended using of Indium foil or thermal conductive and soft material between bottom of the case and heatsink for thermal interface. It's undesirable to use thermal grease for this. Avoid back reflection to the device. It may give impact on the device performance in aspects of spectrum and power stability. It also may cause fatal facet damage. Using of optical isolators is highly recommended to block back reflection.

Do not pull the fiber. Do not bend a fiber with a radius smaller than 3 cm. Fiber tip should always be protected from any contamination or damage during the process of installation. After removing the dust-preventing cap covered at fiber tip, carefully clean fiber tip by wiping through one direction using optical lens cleaning paper or cotton swab dabbed with Iso-Propanol or Ethyl alcohol. Operate the device with clean fiber connector only.

Electrostatic discharge is the primary cause of unexpected product failure. Take extreme precaution to prevent ESD. During device installation, ESD protection has to be maintained - use wrist straps, grounded work surfaces and rigorous antistatic techniques when handling the product.

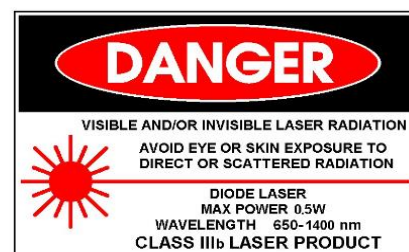

Part-number Identification

SLD1190090HI0D5MXXXX -> 0.5mW output power at 1190nm mean wavelength and 90nm bandwidth, HI-1060 fiber
SLD1190090HI0D5MFXXX -> 0.5mW output power at 1190nm mean wavelength and 90nm bandwidth, HI-1060 fiber, with built-in monitor photodiode

SLD1190090PM0D5MLXXX -> 0.5mW output power at 1190nm mean wavelength and 90nm bandwidth, PM-980 fiber, with loose tube

SLD1190090PM0D5MFLXX -> 0.5mW output power at 1190nm mean wavelength and 90nm bandwidth, PM-980 fiber, with built-in monitor photodiode and fiber loose tube

NOTE: Innolume product specifications are subject to change without notice