

SLD1120020YY030MXXXX

Fiber Coupled Superluminescent Diode (SLD)

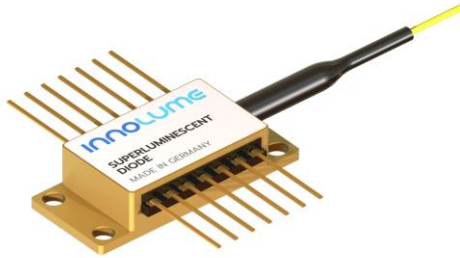

Features:

- High output power at 1120nm
- Low ripples
- Strong linear polarization
- Individual burn-in and thermal cycling screening
- Proprietary anti-reflection coating technology enabling high reliability
- Polarization maintaining PM980 fiber or HI1060 fiber
- 900um loose tube on fiber (optional)
- Built-in monitor photodiode (optional)

Applications:

- Fiber sensors
- Spectroscopy
- Instrumentation

Recommended Operating Conditions

@ CW, the case is mounted on room temperature heatsink

Parameter	Min.	Typ.	Max.	Unit
Chip Temperature	20	25	30	°C
Forward Current		300	500	mA
Output Power	10		30	mW

Characteristics

@ CW, 25°C, 300mA

Parameter	Min.	Typ.	Max.	Unit
Forward Current @ 30mW			500	mA
Forward Voltage		1.5	1.9	V
Mean Wavelength	1110	1120	1130	nm
Bandwidth (FWHM)	15	20		nm
Ripples* (RMS)		0.03	0.3	dB
Polarisation Extinction Ratio (PER)	15	20		dB
Polarisation		TE		

* RMS in 1nm range around ASE maximum, 20pm resolution

Absolute Maximum Ratings

Parameter	Min	Max	Unit
Output Optical Power		100	mW
Forward Current		700	mA
Reverse Voltage		2	V
TEC Current		3	A
TEC Voltage		4	V
Chip Operating Temperature	5	40	°C
Case Operating Temperature	0	70	°C
Storage Temperature	-40	85	°C
Pin Soldering Temperature (max 10 sec, max case temperature 120°C)		300	°C
Fiber Band Radius	3		cm

Typical Performance (for reference only)

@ CW, the case is mounted on room temperature heatsink

Light-Current-Voltage Characteristics

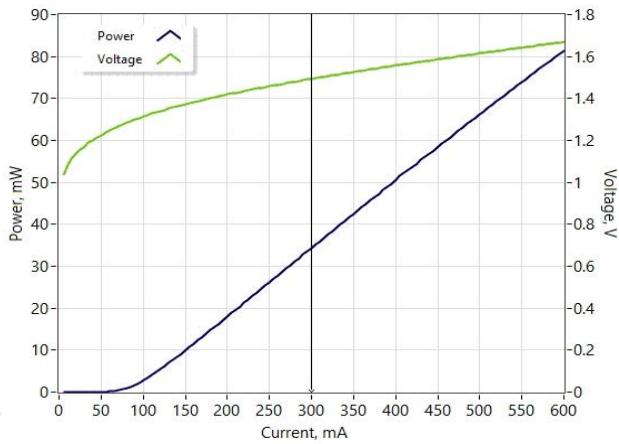

Optical Spectra (res. 1nm)

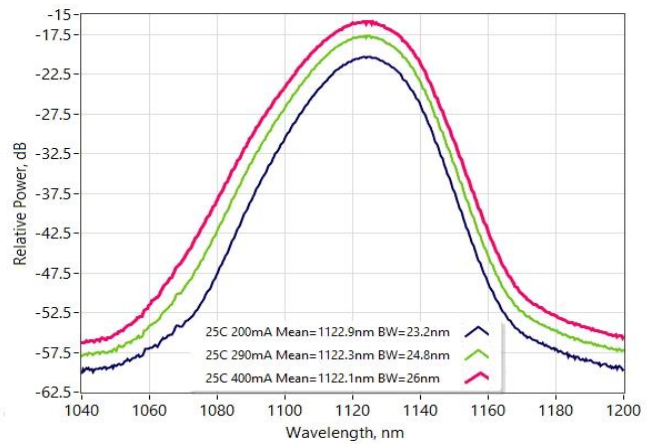

Thermistor specification			Fiber specification			
Parameters	Value	Unit	Parameters	Value	Value	Unit
Type	NTC		Fiber Type	HI1060	PM980	
Resistance @ 25°C	10±0.1	kOhm	Numerical Aperture (Typical)	0.14	0.12	
Beta 25-85°C	3435±1%	K	Cut-off Wavelength	920±50	900±70	nm
			Mode-Field Diameter	6.2±0.3 @1060nm	6.6±0.3 @1060nm	µm
			Cladding Diameter	125±1	125±1	µm
			Coating Diameter	245±15	245±15	µm
			Loose Tube Diameter (optional)	900	900	µm
			Connector	FC/APC	FC/APC	
			Key	narrow	narrow	

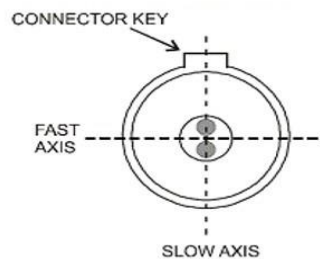
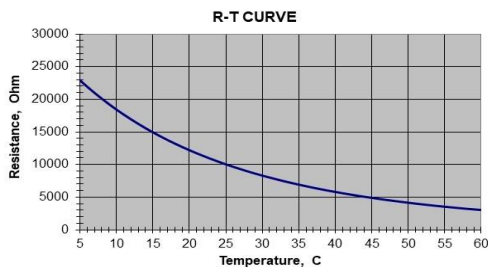

The output light is polarized along the slow axis of PM fiber.

Dimensions (in mm)

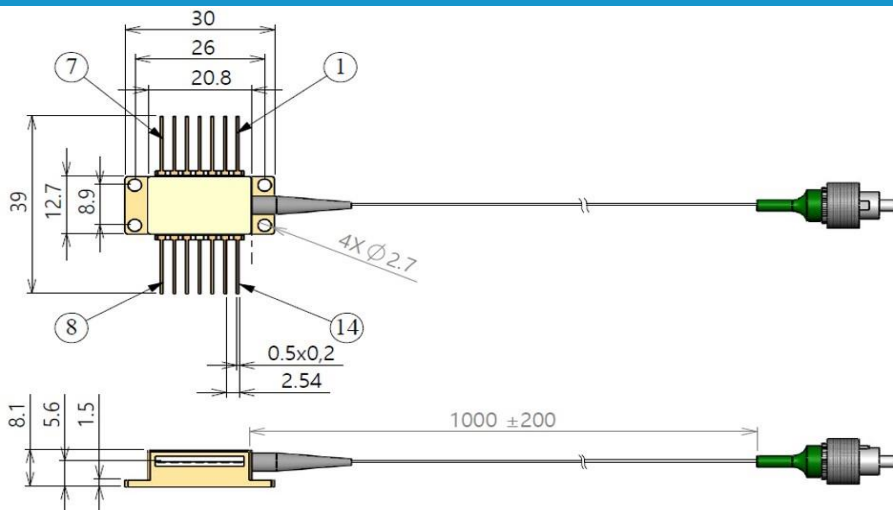

Pin identification:

1. TEC "+"
2. Thermistor
3. Monitor PD anode (Bias "-")
4. Monitor PD cathode (Bias "+")
5. Thermistor
6. -
7. -
8. -
9. -
10. LD anode ("+")
11. LD cathode ("-")
12. -
13. Case
14. TEC "-"

Safety and Operating Instructions

The light emitted from this device is invisible and can be harmful to the human eye. Avoid looking directly into the fiber connector when the device is in operation. Proper laser safety eyewear must be worn during operation with open connector. Absolute Maximum Ratings may be applied to the device for short period of time only. Exposure to maximum ratings for extended period of time or exposure to more than one maximum rating may cause damage or affect the reliability of the device. Operating the device outside of its maximum ratings may cause device failure or a safety hazard. Power supplies used with the component must be employed such that the maximum forward current cannot be exceeded.

A proper heatsink for the device on thermal radiator is required. The device must be mounted on radiator with 4 screws (bolt down in X-style fashion with initial torque set to 0.075Nm and final X-style bolt down at 0.15Nm) or with clamps. The deviation from flatness of radiator surface must be less than 0.05mm. It's recommended using of Indium foil or thermal conductive and soft material between bottom of the case and heatsink for thermal interface. It's undesirable to use thermal grease for this. Avoid back reflection to the device. It may give impact on the device performance in aspects of spectrum and power stability. It also may cause fatal facet damage. Using of optical isolators is highly recommended to block back reflection.

Do not pull the fiber. Do not bend a fiber with a radius smaller than 3 cm. Fiber tip should always be protected from any contamination or damage during the process of installation. After removing the dust-preventing cap covered at fiber tip, carefully clean fiber tip by wiping through one direction using optical lens cleaning paper or cotton swab dabbed with Iso-Propanol or Ethyl alcohol. Operate the device with clean fiber connector only.

Electrostatic discharge is the primary cause of unexpected product failure. Take extreme precaution to prevent ESD. During device installation, ESD protection has to be maintained - use wrist straps, grounded work surfaces and rigorous antistatic techniques when handling the product.

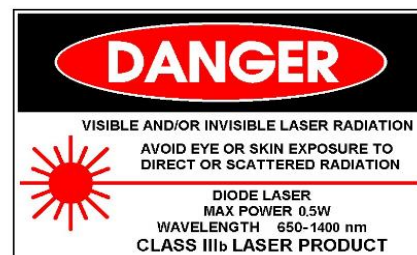
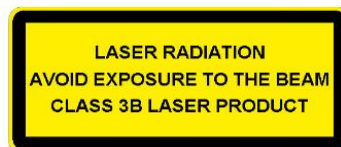

Part-number Identification

SLD1120020HI030MXXXX -> 30mW output power at 1120nm mean wavelength and 20nm bandwidth, HI-1060 fiber
 SLD1120020HI030MFXXX -> 30mW output power at 1120nm mean wavelength and 20nm bandwidth, HI-1060 fiber, with built-in monitor photodiode
 SLD1120020PM030MLXXX -> 30mW output power at 1120nm mean wavelength and 20nm bandwidth, PM-980 fiber, with loose tube
 SLD1120020PM030MFLXX -> 30mW output power at 1120nm mean wavelength and 20nm bandwidth, PM-980 fiber, with built-in monitor photodiode and fiber loose tube

NOTE: Innolume product specifications are subject to change without notice