

DFB13XX000YY050MFXXX

Fiber Coupled Distributed-Feedback Laser Diode

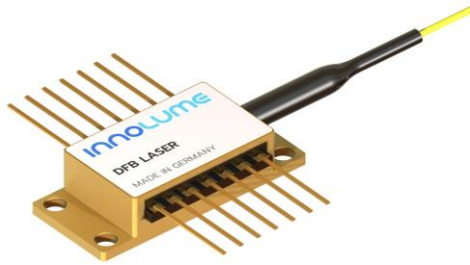

Features:

- Output power > 50mW ex-fiber in 1280-1330nm range
- InAs/GaAs Quantum Dot based diode laser
- Mode-hop free continuous tuning
- Individual burn-in and thermal cycling screening
- Proprietary mirror coating technology enabling high reliability
- Built-in monitor photodiode (optional)
- In-line optical isolator (optional)
- 900um loose tube on fiber (optional)

Applications:

Recommended Operating Conditions

@ CW, the case is mounted on room temperature heatsink

Parameter	Min.	Typ.	Max.	Unit
Chip Temperature	20	25*	40	°C
Forward Current		350	400	mA
Output Power**	5		50	mW

* in some cases may vary depending on the selected wavelength

** kink-free over the entire range

Characteristics

@ CW, 25°C*, 350mA

Parameter	Min.	Typ.	Max.	Unit
Output Power @ 400mA	50			mW
Forward Voltage		1.7	3.5	V
Threshold Current		50	90	mA
Monitor Photodiode Current		20		µA
Monitor Photodiode Responsivity		0.3		µA/mW
Peak Wavelength** (chosen by customer)	1280		1330	nm
Peak Wavelength Tolerance			±1	nm
Wavelength Temperature Tunability		120		pm/°C
Wavelength Current Tunability		2.5		pm/mA
Side-Mode Suppression Ratio (SMSR)	40	50		dB
Polarisation Extinction Ratio (PER)	15	18		dB
Polarisation		TE		

* in some cases may vary in 20-40°C range depending on the selected wavelength

** reachable within wavelength tolerance at power > 50mW

Typical Performance (for reference only)

Light Current Voltage Characteristics

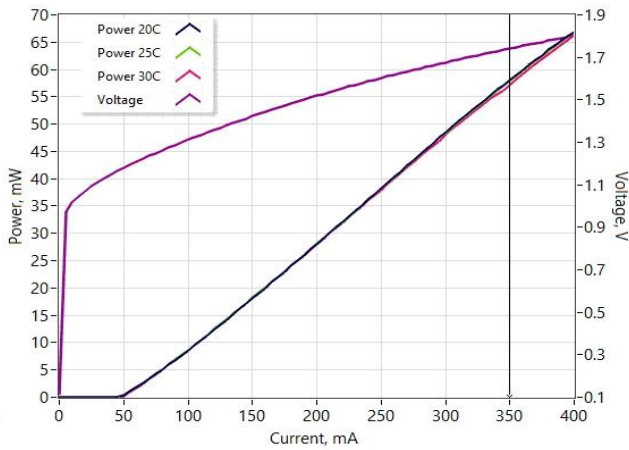

Optical Spectra vs Temperature (res. 10pm)

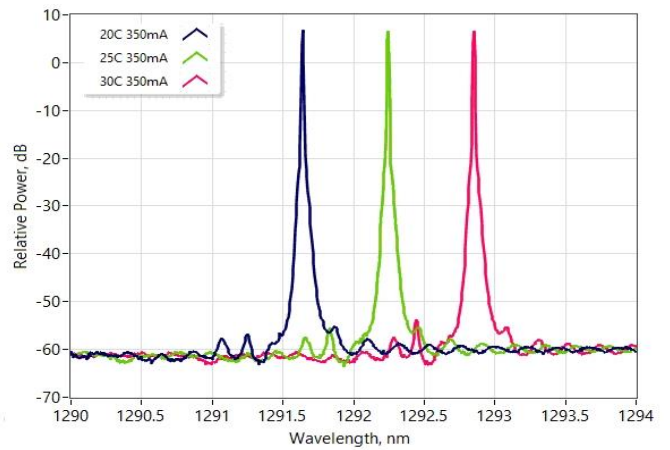

Peak Wavelength Tuning by Current

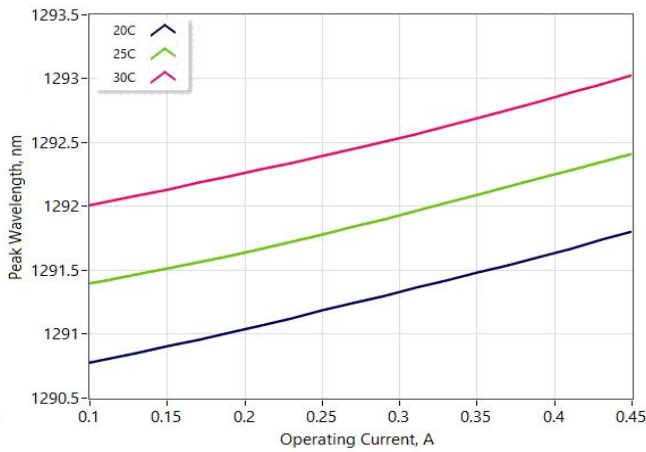

Absolute Maximum Ratings

Parameter	Min	Max	Unit
Forward Current		450	mA
Reverse Voltage		2	V
TEC Current		3	A
TEC Voltage		4	V
Chip Operating Temperature	5	50	°C
Case Operating Temperature	0	70	°C
Pin Soldering Temperature (max 10 sec, max case temperature 120°C)		300	°C
Storage Temperature	-40	85	°C
Fiber Band Radius	3		cm

Thermistor specification			Fiber specification			
Parameters	Value	Unit	Parameters	Value	Value	Unit
Type	NTC		Fiber Type	HI1060	PM1300	
Resistance @ 25°C	10±0.1	kOhm	Numerical Aperture (Typical)	0.14	0.12	
Beta 25-85°C	3435±1%	K	Cut-off Wavelength	920±50	1200±70	nm
			Mode-Field Diameter	6.2±0.3 @1060nm	9.3±0.5 @1300nm	µm
			Cladding Diameter	125±1	125±1	µm
			Coating Diameter	245±15	245±15	µm
			Loose Tube Diameter (optional)	900	900	µm
			Connector	FC/APC	FC/APC	
			Key	narrow	narrow	

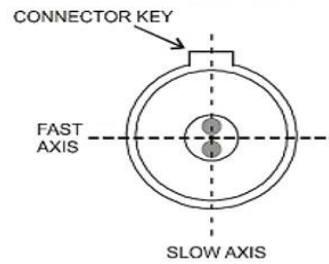

The output light is polarized along the slow axis of PM fiber.

Dimensions (in mm)

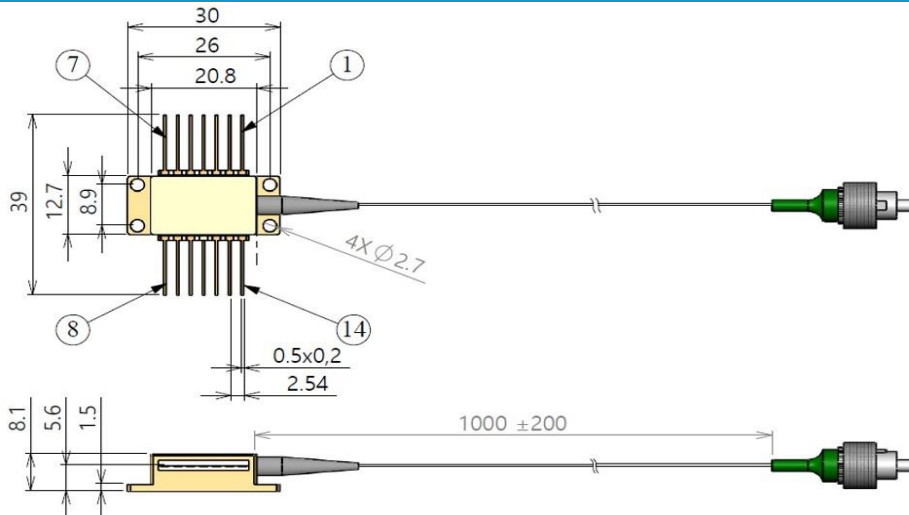

Pin identification:

1. TEC "+"
2. Thermistor
3. Monitor PD anode (Bias "-")
4. Monitor PD cathode (Bias "+")
5. Thermistor
6. -
7. -
8. -
9. -
10. LD anode ("+")
11. LD cathode ("-")
12. -
13. Case
14. TEC "-"

Safety and Operating Instructions

The light emitted from this device is invisible and can be harmful to the human eye. Avoid looking directly into the fiber connector when the device is in operation. Proper laser safety eyewear must be worn during operation with open connector. Absolute Maximum Ratings may be applied to the device for short period of time only. Exposure to maximum ratings for extended period of time or exposure to more than one maximum rating may cause damage or affect the reliability of the device. Operating the device outside of its maximum ratings may cause device failure or a safety hazard. Power supplies used with the component must be employed such that the maximum forward current cannot be exceeded.

A proper heatsink for the device on thermal radiator is required. The device must be mounted on radiator with 4 screws (bolt down in X-style fashion with initial torque set to 0.075Nm and final X-style bolt down at 0.15Nm) or with clamps. The deviation from flatness of radiator surface must be less than 0.05mm. It's recommended using of Indium foil or thermal conductive and soft material between bottom of the case and heatsink for thermal interface. It's undesirable to use thermal grease for this. Avoid back reflection to the device. It may give impact on the device performance in aspects of spectrum and power stability. It also may cause fatal facet damage. Using of optical isolators is highly recommended to block back reflection.

Do not pull the fiber. Do not bend a fiber with a radius smaller than 3 cm. Fiber tip should always be protected from any contamination or damage during the process of installation. After removing the dust-preventing cap covered at fiber tip, carefully clean fiber tip by wiping through one direction using optical lens cleaning paper or cotton swab dabbed with Iso-Propanol or Ethyl alcohol. Operate the device with clean fiber connector only.

Electrostatic discharge is the primary cause of unexpected product failure. Take extreme precaution to prevent ESD. During device installation, ESD protection has to be maintained - use wrist straps, grounded work surfaces and rigorous antistatic techniques when handling the product.

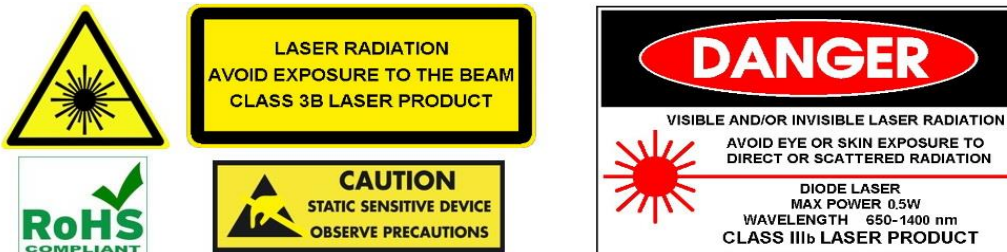

Part-number Identification

DFB1280000HI050MFXXX -> 50mW output power at 1280nm peak wavelength, HI-1060 fiber
 DFB1330D50PM050MFXXX -> 50mW output power at 1330.5nm peak wavelength, PM1300 fiber
 DFB1330D53PM050MFLXX -> 50mW output power at 1330.53nm peak wavelength, PM1300 fiber, with fiber loose tube

NOTE: Innolume product specifications are subject to change without notice