

## 660nm 50mW LD

By converting the external APC circuit board into an ASIC, we package the APC circuit into a traditional TO-can together with the laser chip. From now on, single package APC function included laser diode is realized.

Powered with Arima's proprietary APC **LASER DIODE**™ technology, **ADL-66505TM** is your perfect solution for the stable light power output, compact size, high brightness laser light source.

### Features

1. 660nm 50mW 60°C high reliable operation
2. Saving space and cost of laser module
3. Voltage driven LD, easy to use
4. Highly stable laser output power
5. Strong reverse bias protection
6. High ESD sustainability voltage
7. High speed short protection
8. Power source reverse protection

### Applications

1. Industry : laser level, illumination, meter, scanner, detector
2. Consumer : point light, sweeper, game lighting
3. Health : special wavelength light source

### Absolute maximum ratings

Parameter	Symbol	Rating	Unit
Power supply voltage	$V_{CC}$	3.0~6.0	V
Laser optical output power	$P_o$	50.0	mW
Case temperature	$T_c$	-10 ~ +60	°C
Storage temperature	$T_{stg}$	-40 ~ +85	°C

### Electrical and optical characteristics ( $T_c=25\text{ }^\circ\text{C}$ )

Parameter	Symbol	Min.	Typ.	Max.	Unit	Conditions
Wavelength	$\lambda$	653	660	667	nm	$P_o=50\text{mW}$ , $V_{CC}=3\text{V}$
Operating current	$I_{CC}$	-	93	120	mA	$P_o=50\text{mW}$ , $V_{CC}=3\text{V}$
Parallel divergence angle	$\theta_{//}$	6	9	13	Deg	$P_o=50\text{mW}$ , $V_{CC}=3\text{V}$
Perpendicular divergence angle	$\theta_{\perp}$	13	17	22	Deg	
Parallel FFP deviation angle	$\Delta\theta_{//}$	-3.0	0	+3.0	Deg	
Perpendicular FFP deviation angle	$\Delta\theta_{\perp}$	-3.0	0	+3.0	Deg	
Emission point accuracy	$\Delta x \Delta y \Delta z$	-80	0	+80	um	
Power-Temp stability (60~25°C)	$\Delta P_{OT}$	-10	-	10	%	$P_o=50\text{mW}$ , $V_{CC}=3\text{V}$
Power-Temp stability (-10~25°C)	$\Delta P_{OT}$	-15	-	10	%	$P_o=50\text{mW}$ , $V_{CC}=3\text{V}$
Power-Vcc stability (6.0~3.0V)	$\Delta P_{OV}$	-10	-	10	%	$P_o=50\text{mW}$ , Temp=25°C
Power Range	$\Delta P_o$	-10	-	10	%	$P_o=50\text{mW}$ , $V_{CC}=3\text{V}$
PWM Control mode	PWM	100	-	2000	KHz	Add 10uF capacitance , Duty cycle=50%

\* Effective heat sink is recommended on 6V case due to extra heat

#### ARIMA LASERS CORP.

PHONE: 886-3-4699800 | FAX: 886-3-4699600

E-MAIL: Ldsales@arimlasers.com | www.arimlasers.com

For reference only. Contents above are subject to change without notice.

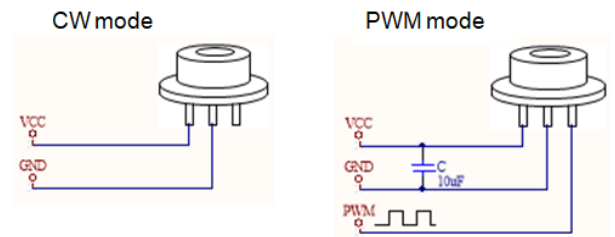
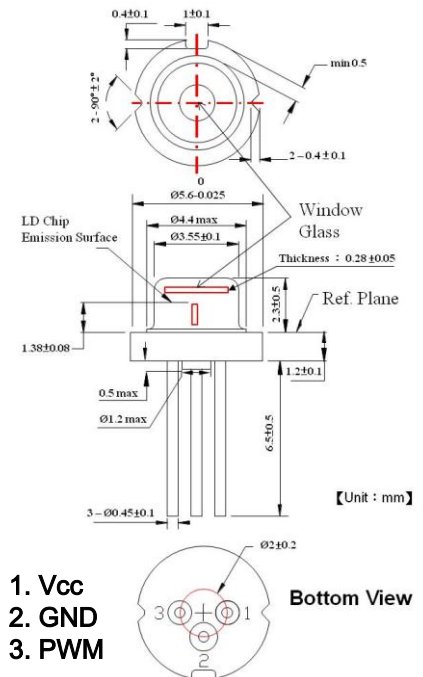

## 660nm 50mW LD

### Block Diagram :

1. Traditional LD needs to connect an external APC circuit board for the constant power operation.
2. **ADL-66505TM** has an APC IC in the **TO-5.6mm** package, and APC circuit board can keep the same optical power.
3. Add capacitance is recommended for stabilizing the PWM control.
4. Battery reverse protection is recommended for protecting the APC Circuit.
5. If the setting power is below 50% of the target power, it is recommended to add >1uF capacitor between Vcc and Gnd.

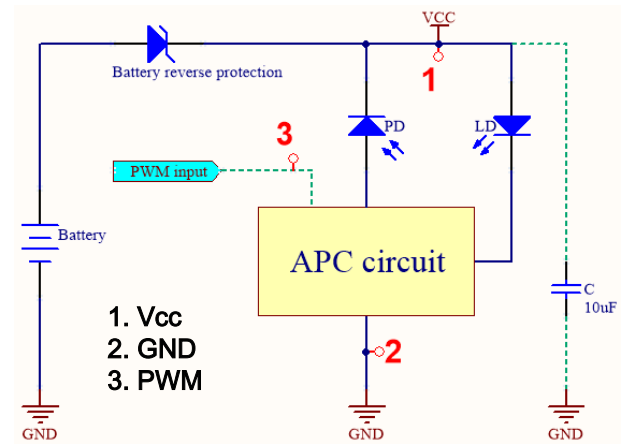

### Product Characteristic Curve :

#### 1. Vcc vs. Po(mW) & Icc(mA)

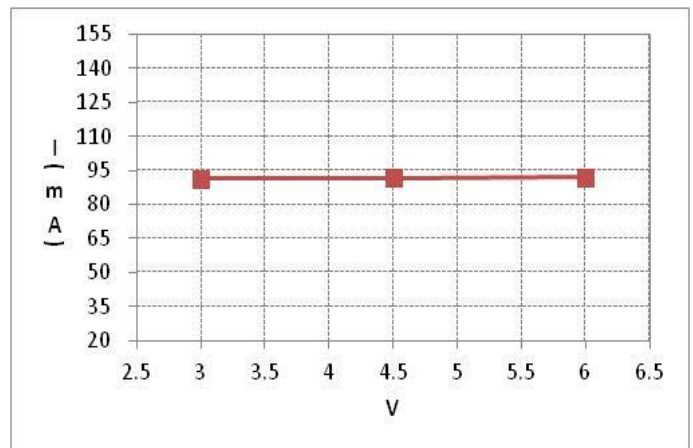
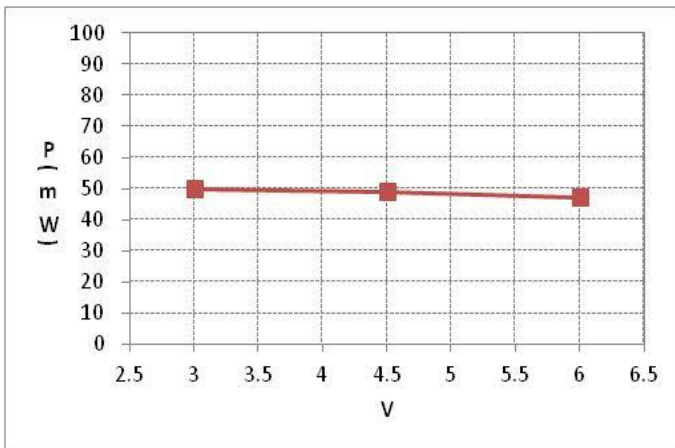

#### 2. Temp. vs. Po(mW) & Icc(mA)

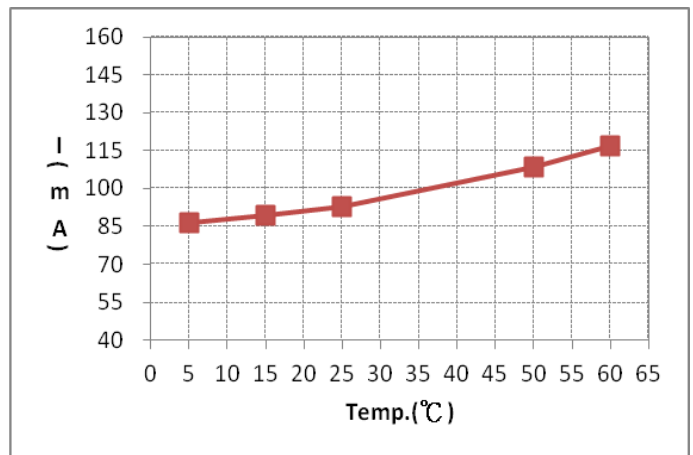
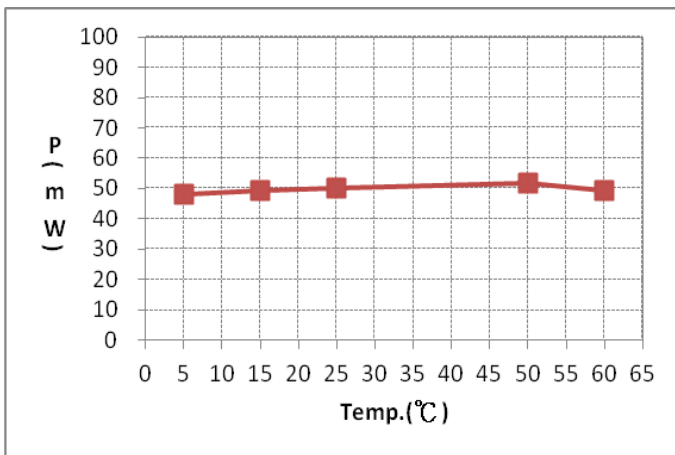

## 660nm 50mW LD

### 3. ESD-V(HM&MM) vs. Po(mW)

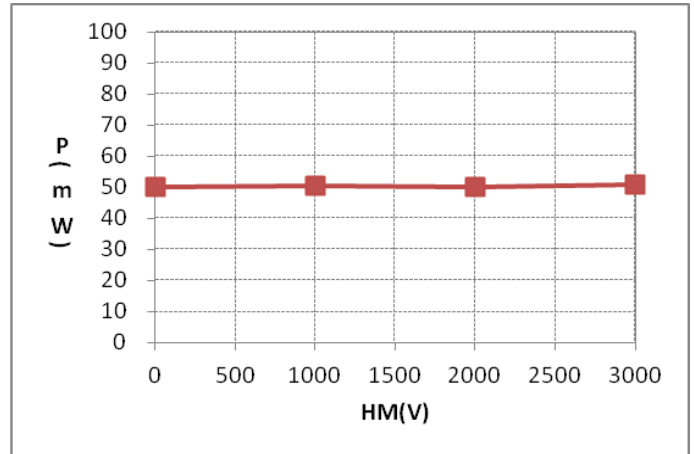
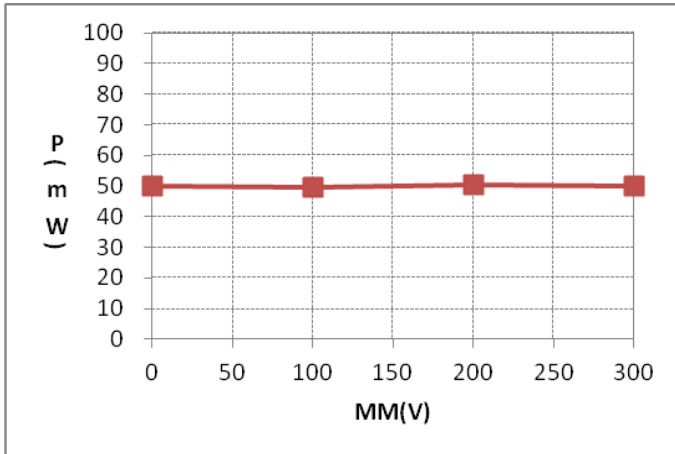

### 4. PWM-Freq(100kHz ,2000kHz) vs. Icc waveform

#### (1) 100KHz

#### (2) 2MHz

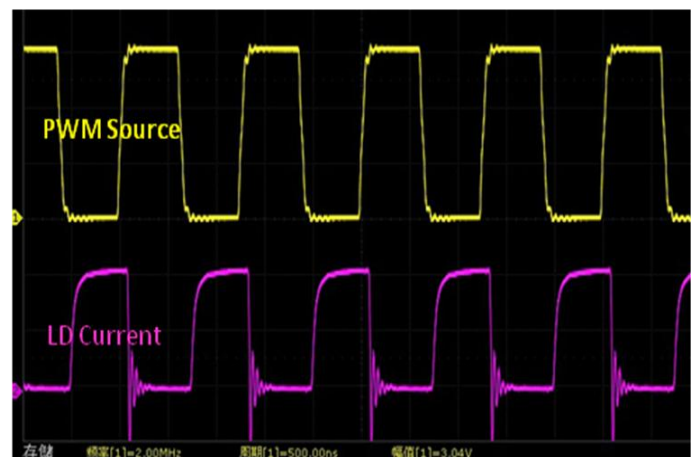
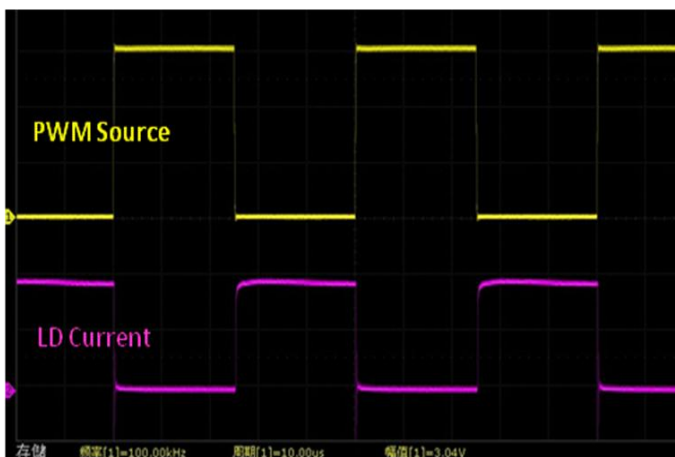

### Special Note :

1. The laser diode cannot be replaced directly when the power supply is started normally.
2. It is recommended to use soft-start circuit before driving the laser diode.
3. Electrical specifications do not apply when operating the device outside of its rated operating conditions. Absolute maximum ratings indicate limits beyond which damage may occur, please avoid occur voltage surge when using.
4. The laser products start-up times within 100us.

#### ● Precautions

- \* To protect laser from overdriving condition, setting VR to maximum value before you turn on Vcc can minimized the laser output power.
- \* Do not operate the device above the maximum rating condition, even momentarily. It may cause unexpected permanent damage to the device.
- \* Semiconductor laser device is very sensitive to electrostatic discharge. High voltage spike current may change the characteristics of the device, or malfunction at any time during its service period. Therefore, proper measures for preventing electrostatic discharge are strongly recommended.
- \* To obtain a stable characteristic and good reliability, the effective heat sink is necessary. So it is recommended that always apply proper heat sink before the device is operating.
- \* Do not look into the laser beam directly by bare eyes. The laser beam may cause severe damage to human eyes.

#### ARIMA LASERS CORP.

PHONE: 886-3-4699800 | FAX: 886-3-4699600

E-MAIL: Ldsales@arimalasers.com | www.arimalasers.com

For reference only. Contents above are subject to change without notice.

