

830nm 150mW High Power Operation

Features

High temperature operation
Small far field angle

Applications

Light source for sensor
Industry

Absolute maximum ratings

Parameter	Symbol	Condition	Rating	Unit
Light output power	P_O	CW	160	mW
Reverse voltage (LD)	V_{RL}	-	2	V
Reverse voltage(PD)	V_{RD}	-	30	V
Forward current(PD)	I_{FD}	-	10	mA
Case temperature	TC	-	-10~+60	°C
Storage temperature	TS	-	-40~+85	°C

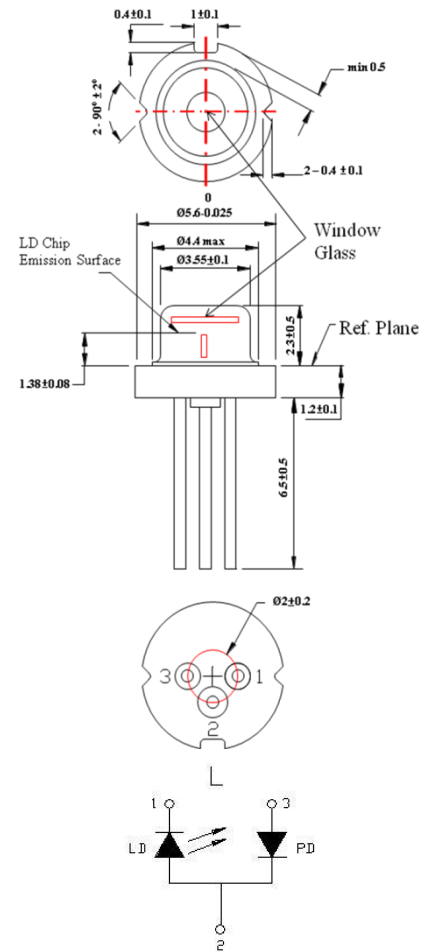

Electrical and optical characteristics ($T_c=25\text{ }^\circ\text{C}$)

Parameter	Symbol	Min.	Typ.	Max.	Unit	Conditions
Peak wavelength	λ	820	830	840	nm	$P_o=150\text{mW}$
Threshold current	I_{th}	-	70	90	mA	
Operating current	I_{op1}	-	220	260	mA	$P_o=150\text{mW}$
Operating voltage	V_{op}	-	1.8	2.4	V	$P_o=150\text{mW}$
Differential efficiency	η	0.8	1.0	-	mW/mA	$P_o=100\text{-}150\text{mW}$
Monitor current	I_m	0.2	0.7	1.3	mA	$P_o=150\text{mW}$, $V_{RD}=5\text{V}$
Parallel divergence angle	$\theta_{//}$	5	7	12	deg	$P_o=150\text{mW}$
Perpendicular divergence angle	θ_{\perp}	-	14	20	deg	
Parallel FFP deviation angle	$\Delta\theta_{//}$	-3	0	3	deg	
Perpendicular FFP deviation angle	$\Delta\theta_{\perp}$	-3	0	3	deg	
Emission point accuracy	$\Delta x\Delta y\Delta z$	-80	0	80	um	

* Sufficient heat dissipation is required for CW operation.

● Precautions

- * Do not operate the device above maximum ratings even short period of time. Doing so may cause unexpected and permanent damage to the device.
- * Take precautions to avoid electrostatic discharge and/or momentary power spikes. A change in the characteristics of the laser or premature failure may result.
- * Proper heat sinking of the device assures stability and lifetime. Always ensure that maximum operating temperatures are not exceeded.
- * Observing visible or invisible laser beams with the human eye directly, or indirectly, can cause permanent damage. Use a camera to observe the laser.
- * No laser device should be used in any application or situation where life or property is at risk in event of device failure.
- * Specifications are subject to change without notice. Ensure that you have the latest specification by contacting us prior to purchase or use of the product.

ARIMA LASERS CORP.

PHONE: 886-3-4699800 | FAX: 886-3-4699600

E-MAIL: Ldsales@arimalasers.com | www.arimalasers.com

For reference only. Contents above are subject to change without notice.

830nm 150mW High Power Operation

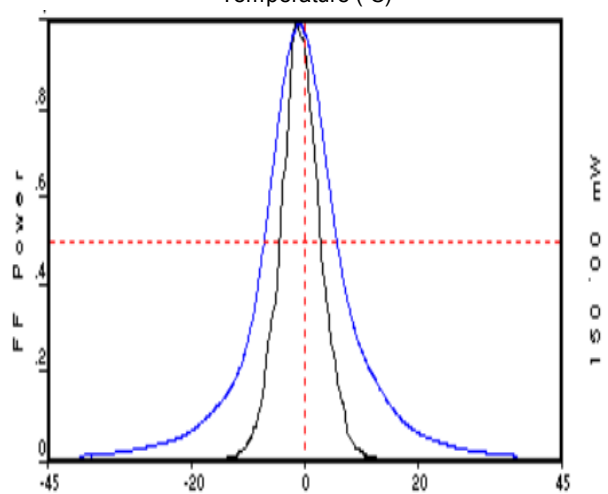
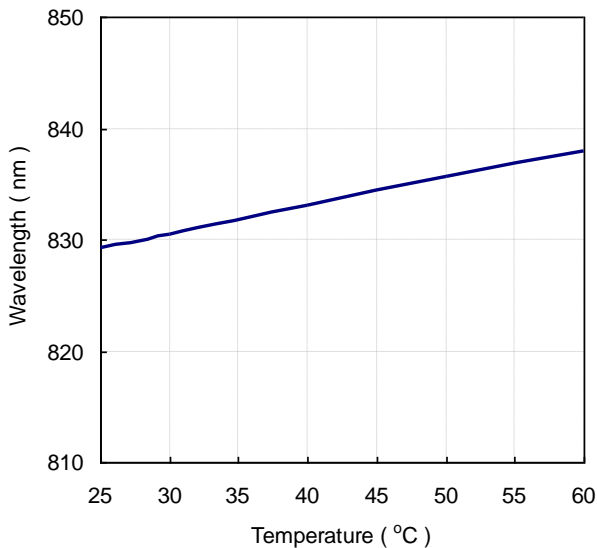
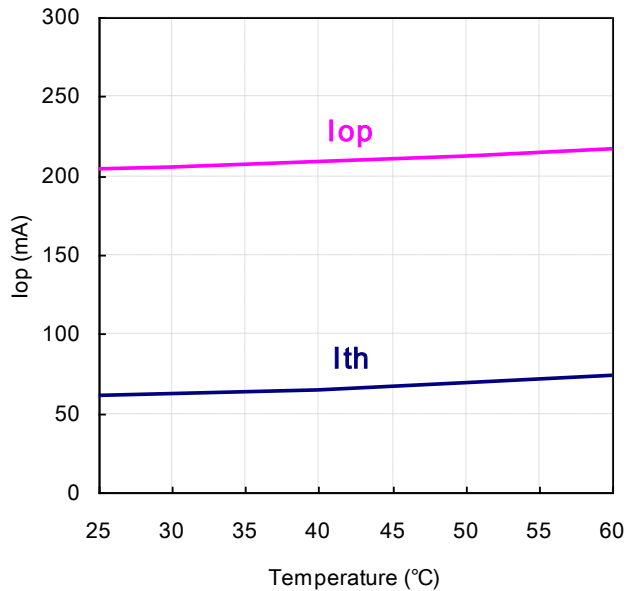
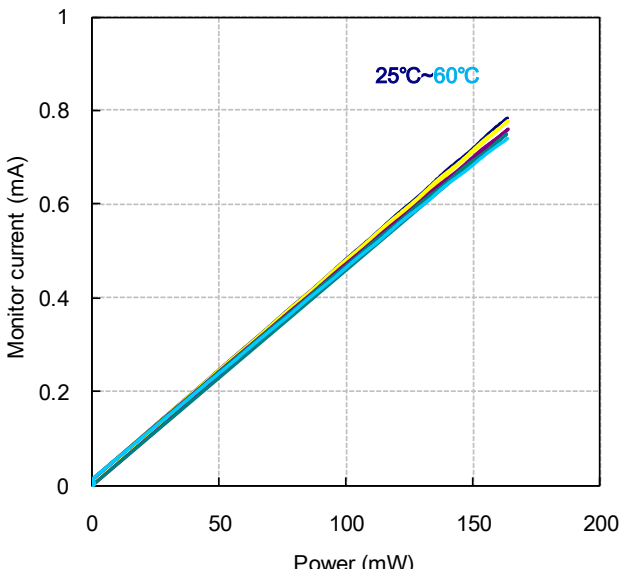
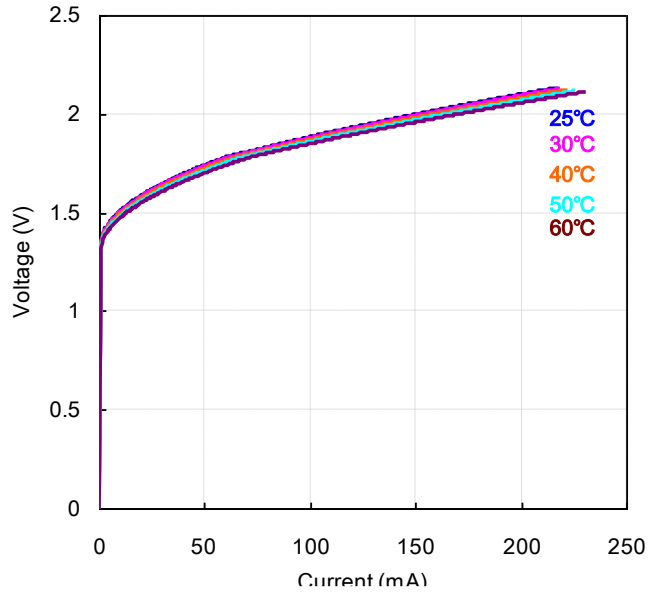
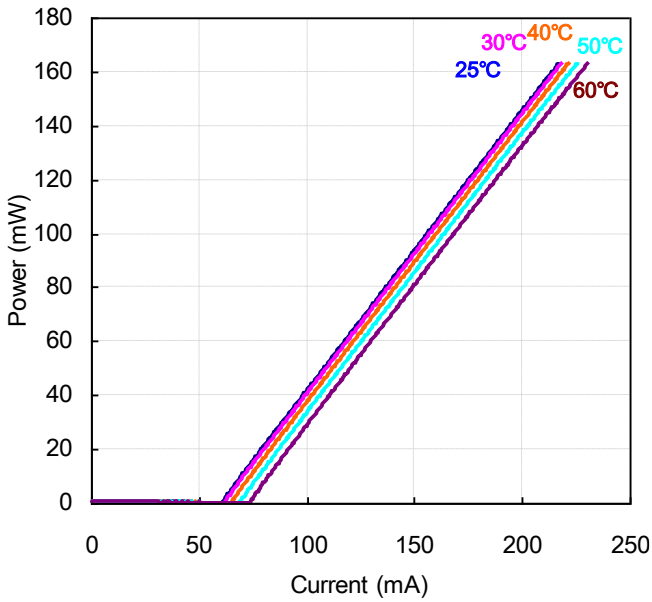

ARIMA LASERS CORP.

PHONE: 886-3-4699800 | FAX: 886-3-4699600

E-MAIL: Ldsales@arimalasers.com | www.arimalasers.com

For reference only. Contents above are subject to change without notice.

Arima
LASERS