

Features

- High reliability
- Spectral Selectivity
- Easy to use in lock-in circuits
- Temperature stabilization
- Parabolic reflector with window

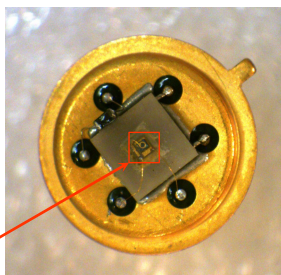

LED chip

Description

Light emitting diode **LED07HP-TEC-PRW** demonstrates typical maximum of emitting wavelength of $\lambda_p = 0.73 \mu\text{m}$ ($I = 100 \text{ mA}$, $f = 0.5 \text{ KHz}$, duty cycle: 50%).

Light emitting diode **LED07HP-TEC-PRW** is equipped with quartz window, thermo-electrical cooler (TEC) and thermistor for stabilizing of temperature.

The components is mounted in a standard 9.2 mm TO-5 package with parabolic reflector (PR).

Related products: **LED07HP-TEC-PRW** can be used in optical pair with our [PD24](#) photodiodes.

Applications

- Measuring equipment
- Gas analysis (H_2)
- Analytical spectral devices

Options

- Power supply: [LED Driver DLT-27M](#)
- Power supply: [LED Driver DLT-37M](#)

General characteristics

Package	Parameter	Symbol	Value	Unit
TO-5 with TEC-PRW	Maximum operating current	I^*_{QCW}	150	mA
		I^{**}_{Pulsed}	1500	
	Soldering temperature	T_s	+ 230	$^{\circ}\text{C}$
	Operating temperature	T_{opr}	- 30...+ 50	$^{\circ}\text{C}$
	Storage temperature	T_{stg}	- 55...+ 60	$^{\circ}\text{C}$
	Weight	m	3.65	g
	Size	D	15.0	mm
H		23.0		

* Quasi-CW mode: Repetition rate: 0.5 kHz, pulse duration: 1 ms, duty cycle: 50%

** Pulse mode: Repetition rate: 0.5 kHz, pulse duration: 2 μs , duty cycle: 0.1%

Electrical and optical characteristics

Parameter	Symbol	Condition	Min	Max	Unit
Peak emission wavelength	λ_p	$I_F = 100 \text{ mA}$	$\lambda_{typ} = 0.73$		μm
			0.72	0.74	
Spectral FWHM	$\Delta\lambda$	$I_F = 100 \text{ mA}$	35	55	nm
Pulse optical power	P^*_{QCW}	$I_F = 100 \text{ mA}$	25	55	mW
	P^{**}_{Pulsed}	$I_F = 1000 \text{ mA}$	150	350	
Forward voltage	V_F	(*)	1.6	2.0	V
Switching time	τ		10	30	ns

* Quasi-CW mode: repetition rate: 0.5 kHz, pulse duration: 1 ms, duty cycle: 50%, current: 100 mA

** Pulse mode: repetition rate: 0.5 kHz, pulse duration: 2 μs , duty cycle: 0.1%, current: 1 A

TEC T0506.1MC0400710.TB103 parameters (without load)

Parameter	Symbol	Condition	Value	Unit
Maximum Current	I_{max}	ΔT_{max}	1.50	A
Maximum Voltage	U_{max}	ΔT_{max}	0.80	V
Cooling power	q_{max}	-	1.30	W
Temperature range	ΔT_{max}	vacuum	70	K
Thermistor resistance	R_t	$T = + 20 \text{ }^\circ\text{C}$	10.00	kOhm

Electroluminescence spectra

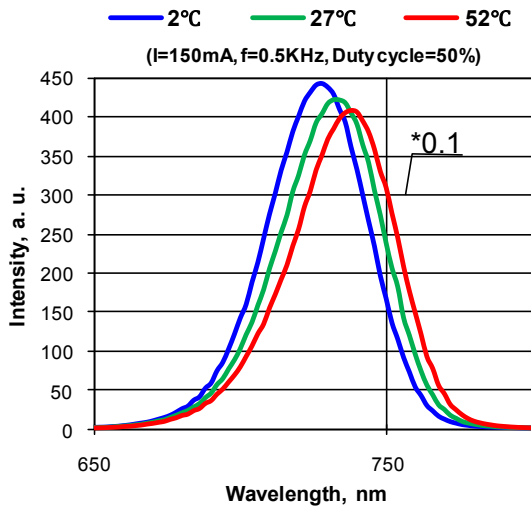

Pulse optical power vs. current

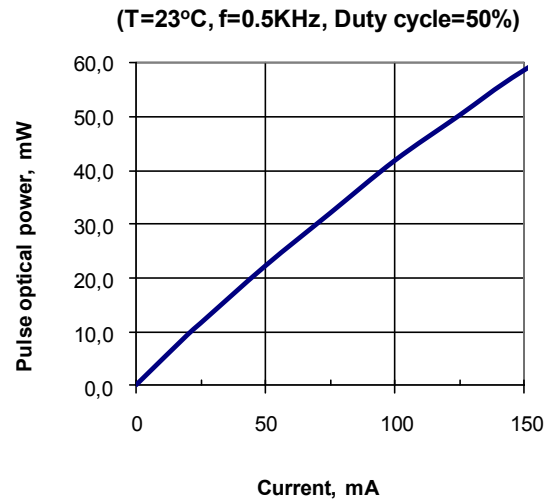

Current vs. voltage

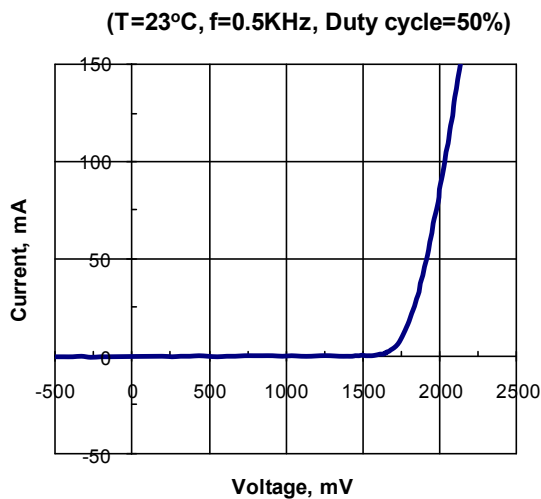

Field pattern

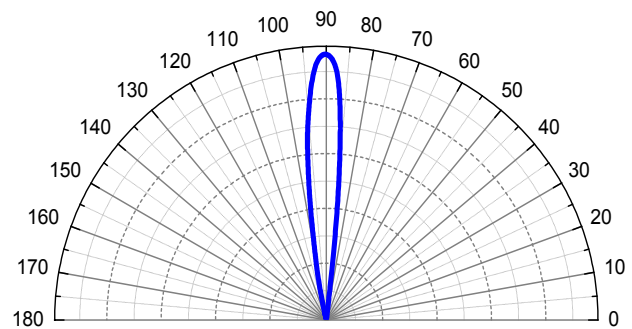

▼ TO-5 package with PR — dimensions (mm)

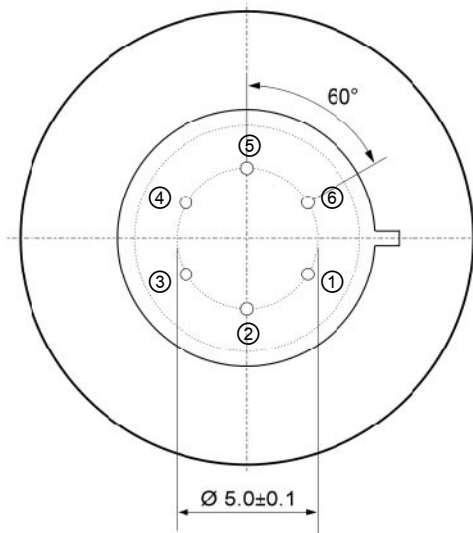
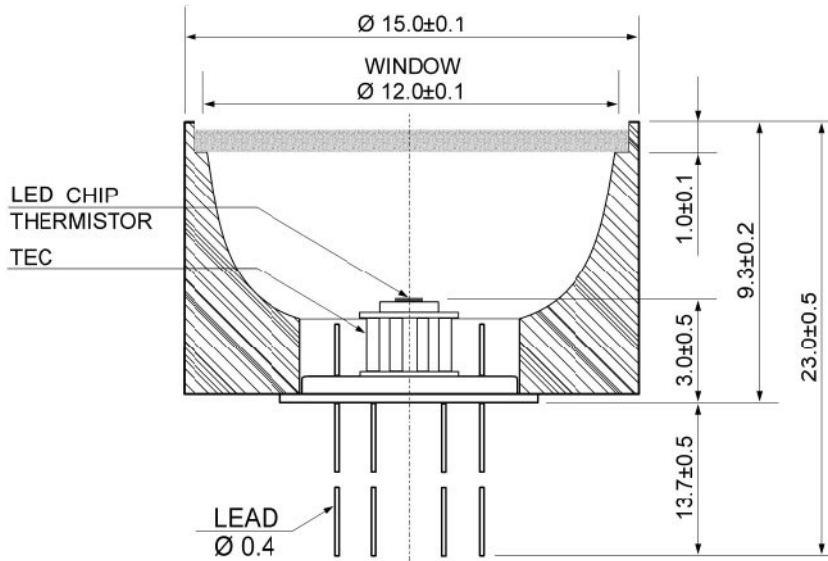

Pin	Description
①	TEC (anode)
②	Diode (anode)*
③	Diode (cathode)*
④	Thermistor TC103
⑤	
⑥	TEC (cathode)

* **Attention:** Pin polarity can be changed on request.