

PRODUCT DATA SHEET

Laser Diode (HHL w/fiber package)

Model FB-M1700-150HF

Specification	Symbol	Typical	Unit
Laser Emitter (at Top=25 degree)			
Peak Wavelength	λ_{op}	1700±20	nm
CW Optical Output Power	P_{op}	0.15	W
Operation Current	I_{op}	<2	A
Operation Voltage	U_{ld}	1.25±0.1	V
Threshold Current	I_{th}	<1	A
Spectrum Half-Width (FWHM)	$\Delta\lambda$	<7	nm
Operation Mode		Continuous	-
Optical Fiber			
Fiber diameter		200	μm
Coating diameter		220	μm
Outer diameter		3	mm
Numerical Aperture		0,22	-
Fiber Length		1	m
Optical Connector Type		FC	-
Photo Diode Monitor			
PD Monitor Current		1-1000	μA
PD Reverse Voltage		9	V
TEC			
Maximum Current		5	A
Maximum Operation Voltage		3,8	V
Other parameters			
Thermistor Resistance		10	kilohm
Operation Temperature Range		-20... +40	degree
Wavelength Temperature Coefficient	$\Delta\lambda/\Delta T$	7.0±0.5	Å/degree
Guaranteed Life Time		1	year



Thermistor resistance diagram

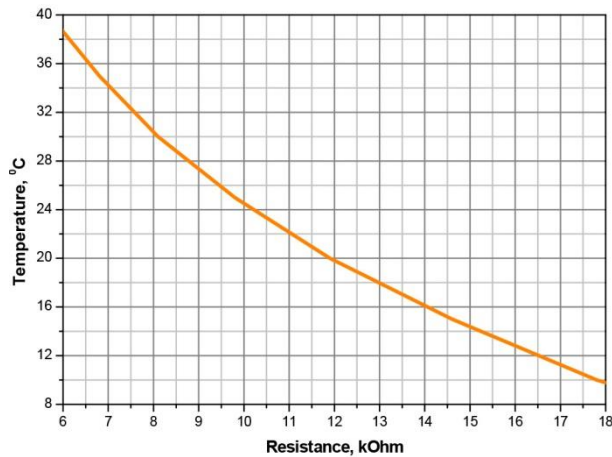

Dimensions and pinouts

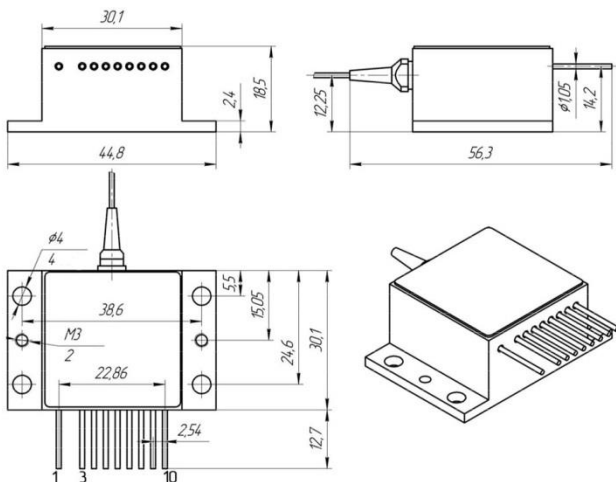

- 1-TEC (-)
- 2-
- 3-
- 4- Laser Anode(+)
- 5- Thermistor (2)
- 6- Thermistor (1)
- 7- Laser Cathode (-)
- 8- PD Anode (+)
- 9- PD Cathode (-)
- 10- TEC (+)