

High Power Laser Diode C-mount



Part Number: C-130

High Power C-mount
Multi-Mode Fabry-Perot
CW Wavelength at 1320nm
Lensed Options Available



Features

- High Output Power
- High Dynamic Range
- High Efficiency
- Standard C-mount
- Cost Effective

Application

- Professional Medical



SemiNex delivers the highest available power at infrared wavelengths between 12xx and 19xx nm. When necessary, we will further optimize the design of our InP & GaSb laser chips to meet our customers' specific optical and electrical performance needs. Diodes, bars and packages are tested to meet customer and market performance demands. Typical results and packaging options are shown. Contact SemiNex for additional details or to discuss your specific requirements.

High Power Laser Diode C-mount



Specification

C-130



Optical	Symbol	Typ.	Units
Center Wavelength	λ_c	1320	nm (± 20)
Output Power (CW)*	P_{out}	5.7	watts ($\pm 10\%$)
Emitter Width	W	95	μm
Spectral Width FWHM	$\Delta\lambda$	15	nm
Slope Efficiency	η	0.5	W/A
Fast Axis Div.	θ_{\perp}	28	deg FWHM
Slow Axis Div.	θ_{\parallel}	9	deg FWHM
Electrical	Symbol		Units
Power Conversion Eff.	η	27	%
Threshold Current	I_{TH}	0.45	A
Operating Current	I_{op}	14	A
Operating Voltage	V_{op}	1.8	V
Mechanical	Symbol	Range	Units
Operating Temp.**		-40 to 60	$^{\circ}\text{C}$
Storage Temp.		-40 to 80	$^{\circ}\text{C}$

*Specified values are rated at a constant heat sink temperature of 20 $^{\circ}\text{C}$.

**High temperature operation will reduce performance and MTTF.
Unless otherwise indicated all values are nominal.

*Available Lenses

Suffix	Description
-118	Lens Collimated $<10\text{mrad}$ $f=274\mu\text{m}$, 5mm Lg
-134	Lens Matched $f=274\mu\text{m}$, 5mm Lg
-141	Lens, FAC, $f=590\mu\text{m}$, 5mm Lg, Collimated 5mrad
-186	Lens, FAC, $f=590\mu\text{m}$, 5mm Lg, WD=50 μm

High Power Laser Diode C-mount



SemiNex Laser Diodes C-130

Graphs & Data

Typical C-mount L-I-V Characteristics

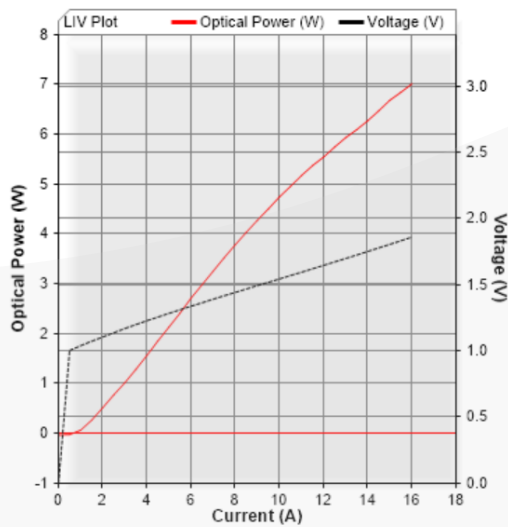

Typical C-mount Output Spectrum

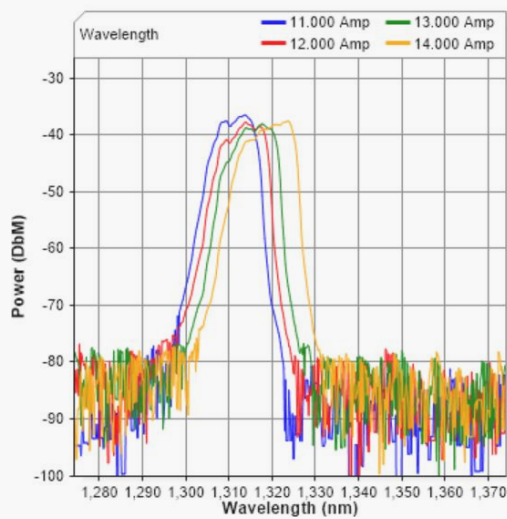

High Power Laser Diode C-mount



Mechanical Drawing

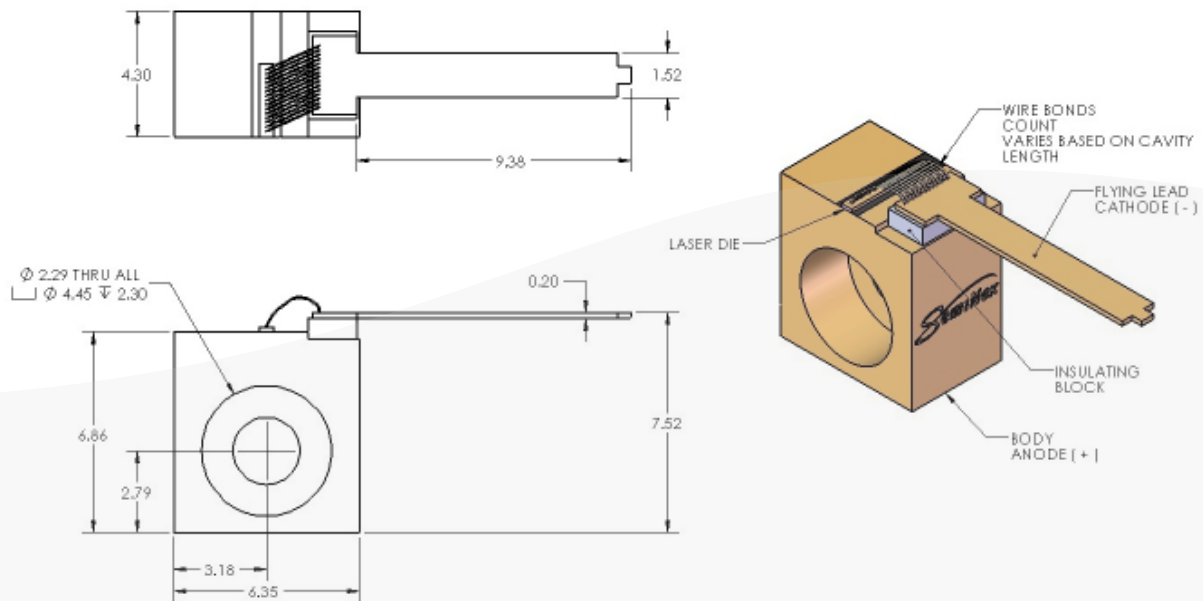

All statements, technical information and recommendations related to the product herein are based upon information believed to be reliable or accurate. The accuracy or completeness herein is not guaranteed, and no responsibility is assumed for any inaccuracies. The user assumes all risks and liability whatsoever in connection with the use of a product or its application. SemiNex Corporation reserves the right to change at any time without notice the design, specification, deduction, fit or form of its described herein, including withdrawal at any time of a product offered for sale herein. Users are encouraged to visit www.seminex.com for the latest data. SemiNex Corporation makes no representations that the products herein are free from any intellectual property claims of others. Please contact SemiNex for more information. 2024 SemiNex Corporation



High Power Laser Diode C-mount



Mechanical Drawing

C-130-118

C-130-134

C-130-141

C-130-186

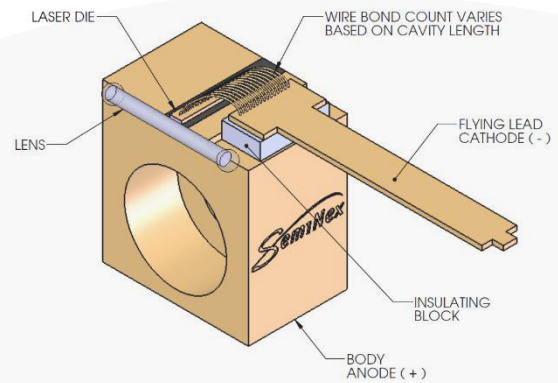
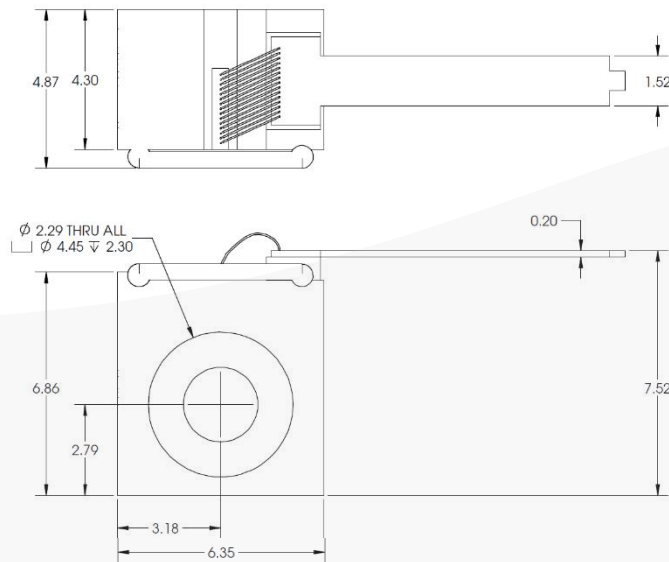

All statements, technical information and recommendations related to the product herein are based upon information believed to be reliable or accurate. The accuracy or completeness herein is not guaranteed, and no responsibility is assumed for any inaccuracies. The user assumes all risks and liability whatsoever in connection with the use of a product or its application. SemiNex Corporation reserves the right to change at any time without notice the design, specification, deduction, fit or form of its described herein, including withdrawal at any time of a product offered for sale herein. Users are encouraged to visit www.seminex.com for the latest data. SemiNex Corporation makes no representations that the products herein are free from any intellectual property claims of others. Please contact SemiNex for more information. 2024 SemiNex Corporation



SemiNex Corporation • 153 Andover Street, Suite 201, Danvers, MA 01923 • 978-326-7700 • sales@seminex.com