



First Sensor APD Data Sheet

Part Description AD100-12 SMD

Order # 501597

Version 06-08-15

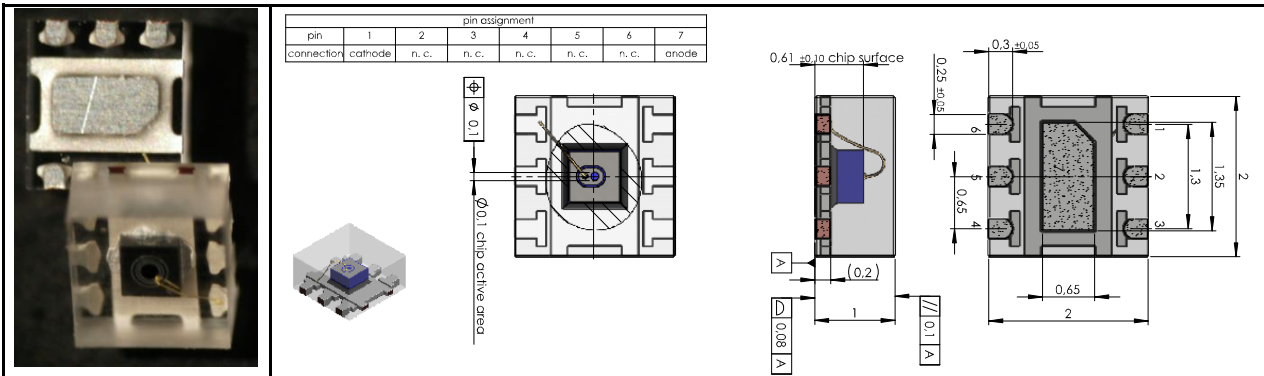

Features

- APD with 0.008 mm² active area
- Optimized for 550 nm to 750 nm
- Very high sensitivity
- High cut-off frequency
- Ultra low temperature coefficient

Description

Circular active area APD chip with 100 μm diameter. Clear QFN package with very compact design. Lead-free reflow solderable (MSL3).

Application

- Laser range finder
- High speed photometry
- High speed optical communications
- Medical equipment

RoHS

2002/95/EC



Absolute maximum ratings

Symbol	Parameter	Min	Max	Unit
T _{STG}	Storage temp	-40	100	°C
T _{OP}	Operating temp	-20	85	°C
M _{max}	Gain (I _{p0} = 1 nA)	200		
I _{PEAK}	Peak DC current		0.25	mA

Spectral response (M = 100)

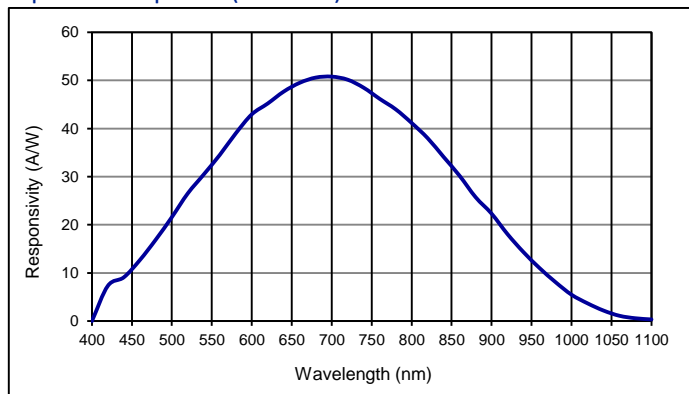

Schematic

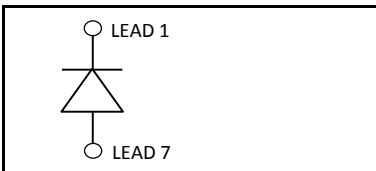

Electro-optical characteristics @ 23 °C

Symbol	Characteristic	Test Condition	Min	Typ	Max	Unit
	Active area		diameter 100			μm
	Active area		0.0078			mm ²
I _D	Dark current	M = 100		0.05	0.5	nA
C	Capacitance	M = 100		0.5		pF
	Responsivity	M = 100; λ = 660 nm	0.45	0.50		A/W
t _R	Rise time	M = 100; λ = 660 nm; R _L = 50 Ω		0.12		ns
	Cut-off frequency	-3dB, phase shift mode		3		GHz
V _{BR}	Breakdown voltage	I _R = 2 μA, V _{BR} - binning available	60	90	120	V
	Temperature coefficient	Change of V _{BR} with temperature		0.2		V/K
	Excess noise factor	M = 100		2.0		
	Excess noise index	M = 100		0.15		

European, International Sales:



First Sensor AG
 Peter-Behrens-Strasse 15
 12459 Berlin
 Germany
 T +49 30 6399 2399
 F +49 30 639923-752
 sales.opto@first-sensor.com

USA:



First Sensor Inc.
 5700 Corsa Avenue #105
 Westlake Village
 CA 91362 USA
 T +1 818 706 3400
 F +1 818 889 7053
 sales.us@first-sensor.com



Quantum efficiency (23 °C)

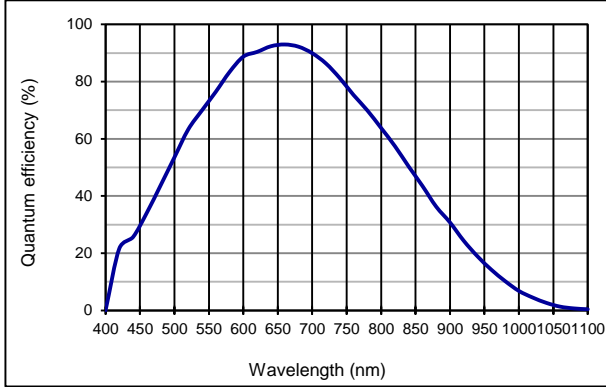

Capacitance as fct of reverse bias (23 °C)

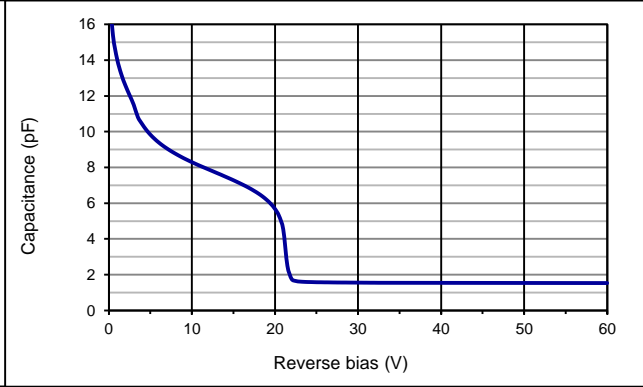

Multiplication as fct of bias (23 °C)

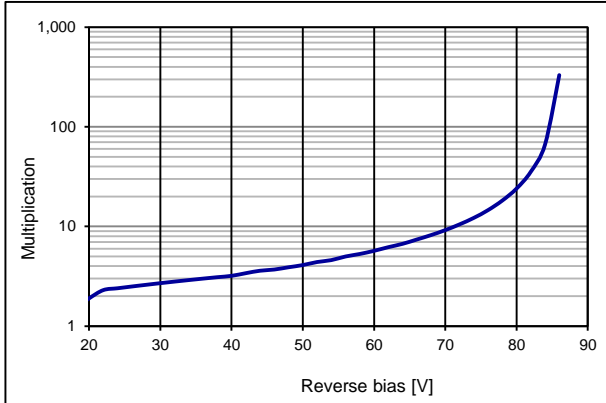

Dark current as fct of bias (23 °C)

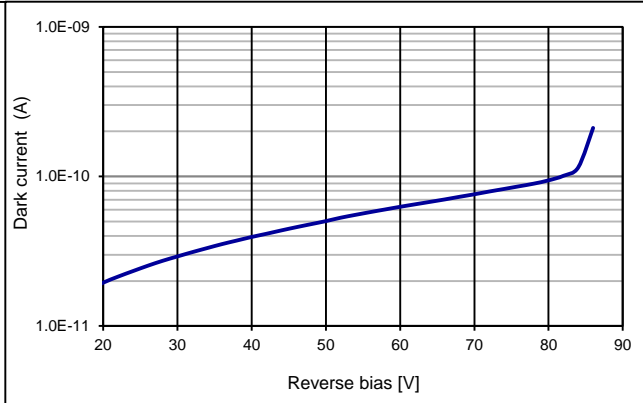

European, International Sales:



First Sensor AG
 Peter-Behrens-Strasse 15
 12459 Berlin
 Germany
 T +49 30 6399 2399
 F +49 30 639923-752
 sales.opto@first-sensor.com

USA:



First Sensor Inc.
 5700 Corsa Avenue #105
 Westlake Village
 CA 91362 USA
 T +1 818 706 3400
 F +1 818 889 7053
 sales.us@first-sensor.com

Package dimension

Production quantities on reel (3000 pcs/ reel), sample quantities in tray

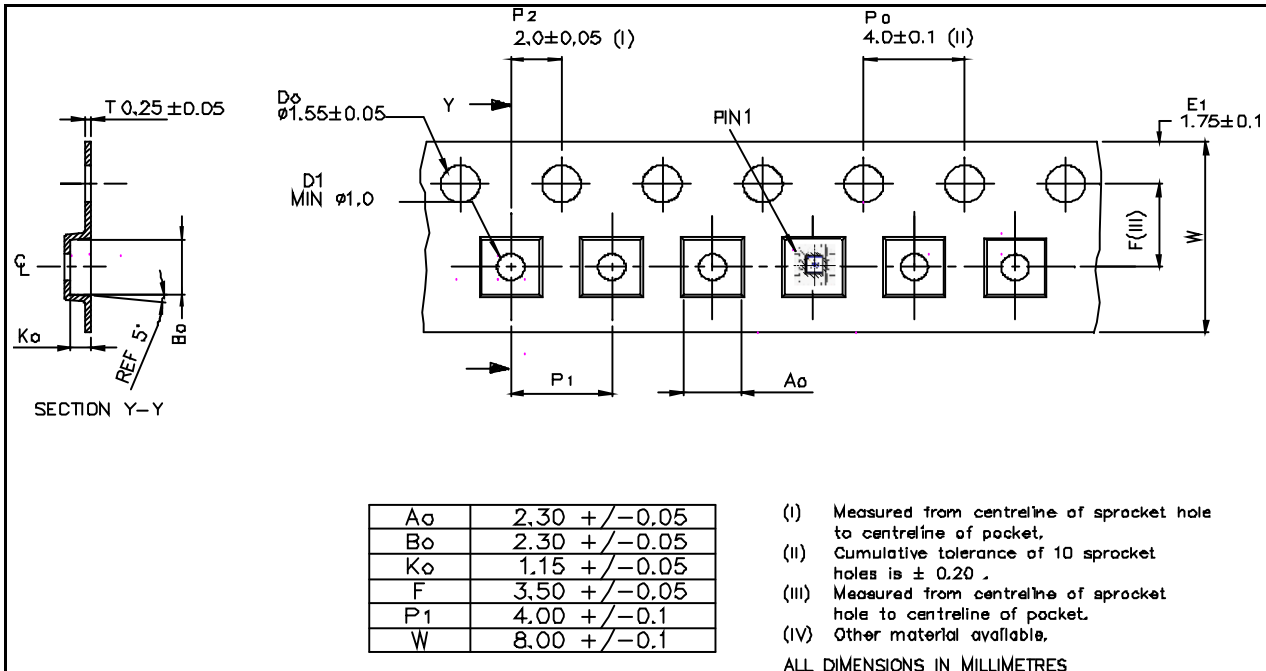

Application hints moisture sensitivity:

- This product has MSL 3 according to JEDEC, i.e. a floor life of 168h at 30°C and 60% relative humidity.
- The reels are shipped in dry packs. Once dry packs are opened or damaged the floor life has to be considered.
- Reflow soldering after floor life is exceeded might cause damage to the component.
- After floor life is exceeded the reel has to be baked or dried before reflow soldering to avoid failures.
- The recommended baking condition according to JEDEC STD-033C is 13 days at 40°C and 5% relative humidity.

Disclaimer: Due to our strive for continuous improvement, specifications are subject to change within our PCN policy according to JESD46C.

European, International Sales:



First Sensor AG
 Peter-Behrens-Strasse 15
 12459 Berlin
 Germany
 T +49 30 6399 2399
 F +49 30 639923-752
 sales.opto@first-sensor.com

USA:



First Sensor Inc.
 5700 Corsa Avenue #105
 Westlake Village
 CA 91362 USA
 T +1 818 706 3400
 F +1 818 889 7053
 sales.us@first-sensor.com