

**Features**

- APD with 0.04 mm<sup>2</sup> active area
- 230 µm diameter active area
- High gain at low bias voltage
- Fast rise time, low capacitance
- Optimum gain: 50-60

**Description**

Circular active area APD chip with 230 µm diameter. Metal can type hermetic TO52 package with clear glass window. Two TO52 types available, customization on request.

**Application**

- Laser range finder
- High speed photometry
- High speed optical communications
- Medical equipment

**RoHS**

2002/95/EC



**Absolute maximum ratings**

Symbol	Parameter	Min	Max	Unit
T <sub>STG</sub>	Storage temp	-55	125	°C
T <sub>OP</sub>	Operating temp	-40	100	°C
M <sub>max</sub>	Gain (I <sub>PO</sub> = 1 nA)	200		
I <sub>PEAK</sub>	Peak DC current		0.25	mA

**Spectral response (M = 100)**

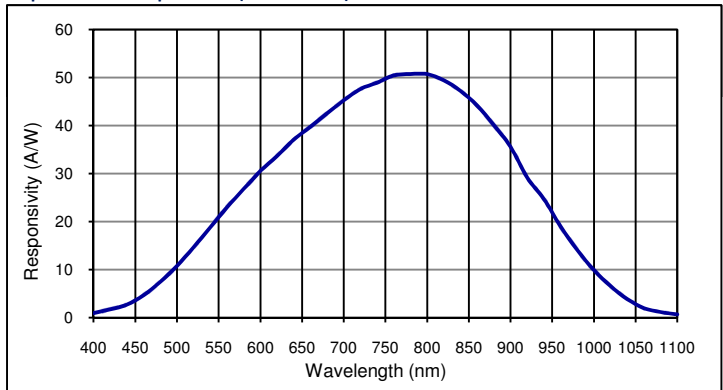

**Schematic 500019**

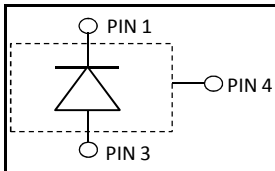

**Schematic 500022**

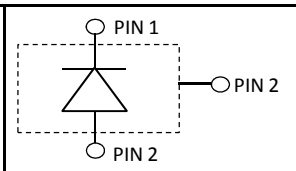

**Electro-optical characteristics @ 23 °C**

Symbol	Characteristic	Test Condition	Min	Typ	Max	Unit
	Active area		diameter 230			µm
	Active area		0.04			mm <sup>2</sup>
I <sub>D</sub>	Dark current	M = 100		0.3	1.0	nA
C	Capacitance	M = 100		1.2		pF
	Responsivity	M = 100; λ = 800 nm	45	50		A/W
t <sub>R</sub>	Rise time	M = 100; λ = 905 nm; R <sub>L</sub> = 50 Ω		0.18		ns
	Cut-off frequency	-3dB		2		GHz
V <sub>BR</sub>	Breakdown voltage	I <sub>R</sub> = 2 µA, V <sub>BR</sub> - binning available	80		200	V
	Temperature coefficient	Change of V <sub>BR</sub> with temperature		0.45		V/K
	Excess noise factor	M = 100		2.2		
	Excess noise index	M = 100		0.2		

**European, International Sales:**



First Sensor AG  
 Peter-Behrens-Strasse 15  
 12459 Berlin  
 Germany  
 Phone: +49-30-6399-2399  
 Fax: +49-30-6399-23752  
 E-Mail: sales.opto@first-sensor.com

**USA:**



Pacific Silicon Sensor, Inc.  
 5700 Corsa Avenue #105  
 Westlake Village  
 CA 91362 USA  
 Phone: +1-818-706-3400  
 Fax: +1-818-889-7053  
 E-Mail: sales@pacific-sensor.com



Quantum efficiency (23 °C)

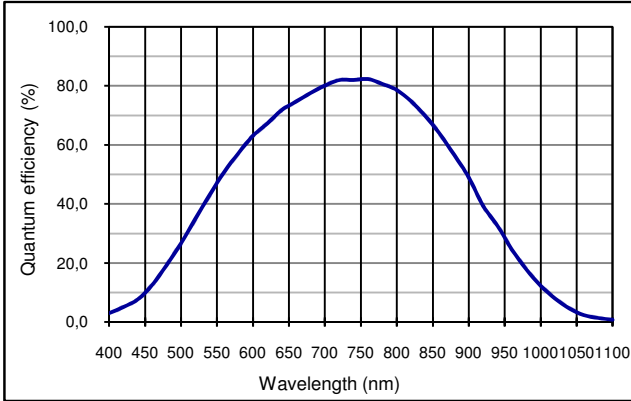

Capacitance as fct of reverse bias (23 °C)

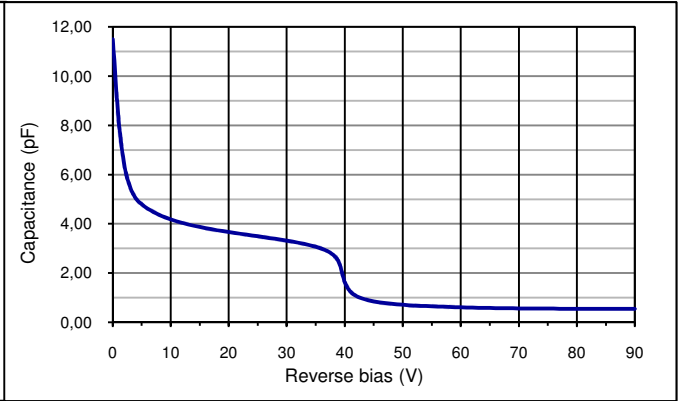

Multiplication as fct of bias and temperature

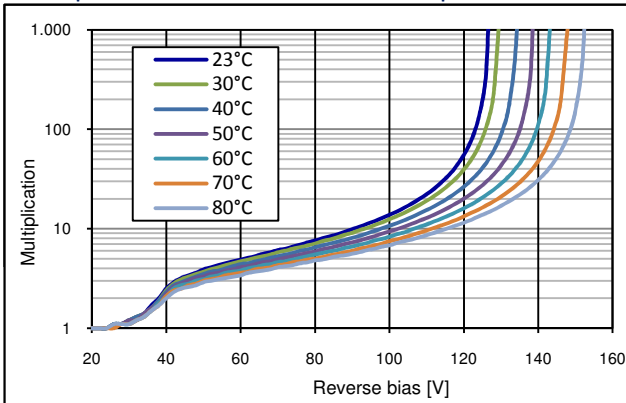

Dark current as fct of bias and temperature

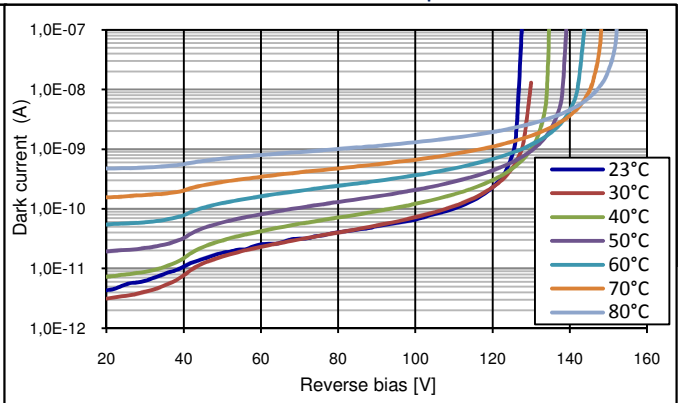

Application hints:

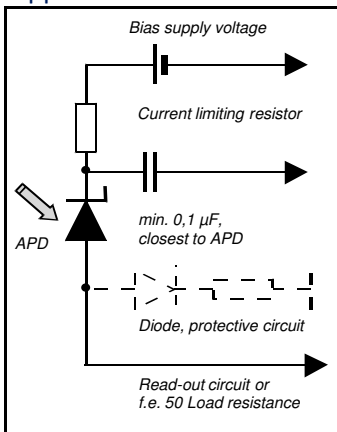

- Current should be limited by a protecting resistor or current limiting - IC inside the power supply
- For low light level applications blocking of ambient light should be used
- For high gain applications bias voltage should be temperature compensated
- Please consider basic ESD protection while handling
- Use low noise read-out - IC
- For further questions please refer to document "Instructions for handling and processing"
- Optimum gain: 50-60

European, International Sales:



First Sensor AG  
 Peter-Behrens-Strasse 15  
 12459 Berlin  
 Germany  
 Phone: +49-30-6399-2399  
 Fax: +49-30-6399-23752  
 E-Mail: sales.opto@first-sensor.com

USA:



Pacific Silicon Sensor, Inc.  
 5700 Corsa Avenue #105  
 Westlake Village  
 CA 91362 USA  
 Phone: +1-818-706-3400  
 Fax: +1-818-889-7053  
 E-Mail: sales@pacific-sensor.com

Order number 500019, Package: TO52S1

Order number 500022, Package: TO52S3

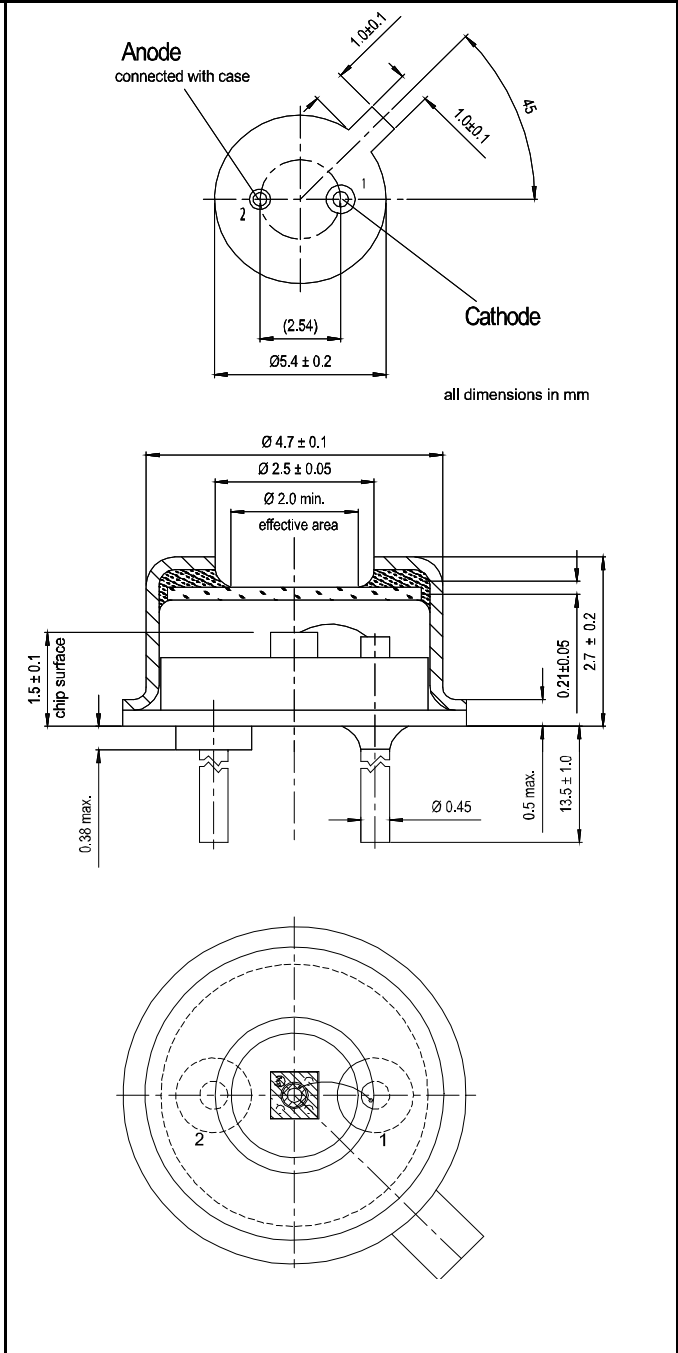
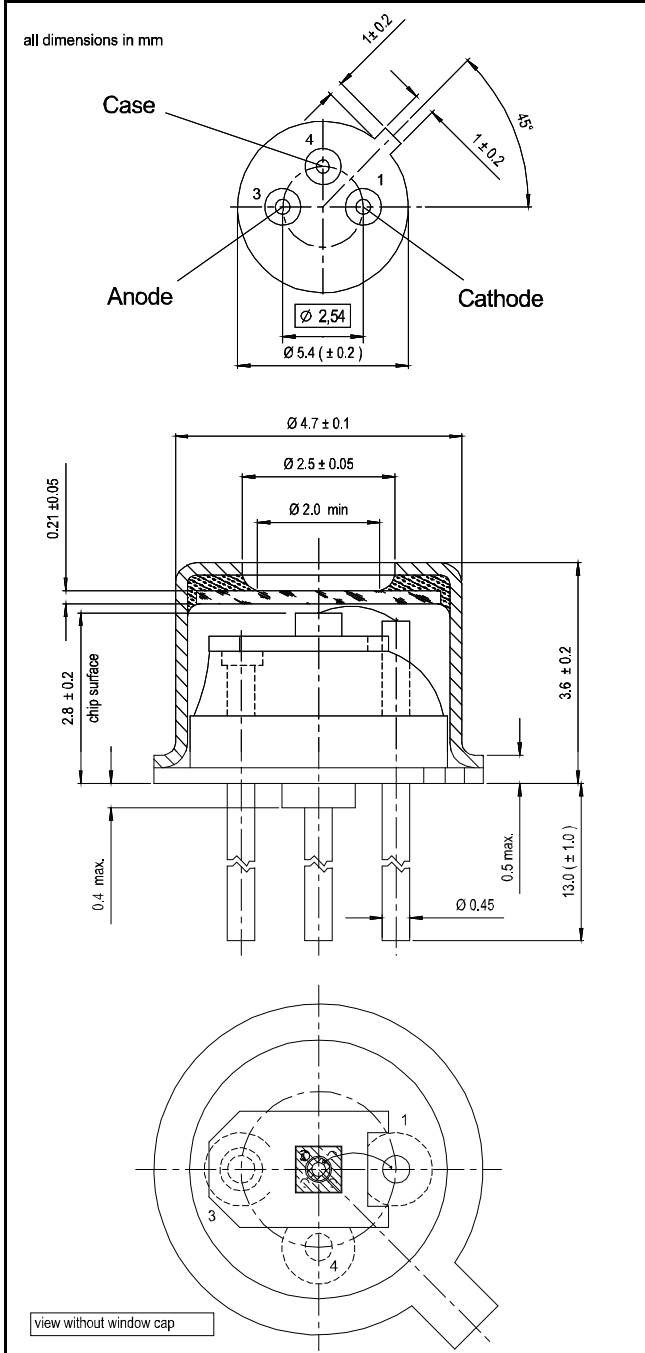

Package dimension:

Small quantities: Foam pad, boxed (12 cm x 16.5 cm)

Disclaimer: Due to our strive for continuous improvement, specifications are subject to change within our PCN policy according to JESD46C.

European, International Sales:



First Sensor AG  
 Peter-Behrens-Strasse 15  
 12459 Berlin  
 Germany  
 Phone: +49-30-6399-2399  
 Fax: +49-30-6399-23752  
 E-Mail: sales.opto@first-sensor.com

USA:



Pacific Silicon Sensor, Inc.  
 5700 Corsa Avenue #105  
 Westlake Village  
 CA 91362 USA  
 Phone: +1-818-706-3400  
 Fax: +1-818-889-7053  
 E-Mail: sales@pacific-sensor.com