

High Power Laser Diode 4CM Module

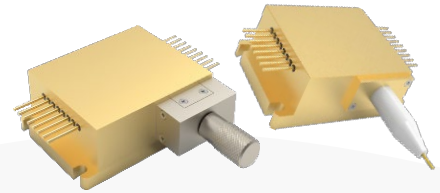

Part Number: 4CM-204

High Power 4CM Fiber Coupled Module
Multi-Mode Fabry-Perot
Detachable Fiber Available
Wavelength at 1470nm



Features

- High Output Power
- High Dynamic Range
- High Efficiency
- 4CM Fiber Coupled Module
- Cost Effective
- Red Aiming Beam
- Thermistor
- Custom Wavelengths Available

Application

- Professional Medical



SemiNex delivers the highest available power at infrared wavelengths between 12xx and 19xx nm. When necessary, we will further optimize the design of our InP & GaSb laser chips to meet our customers' specific optical and electrical performance needs. Diodes, bars and packages are tested to meet customer and market performance demands. Typical results and packaging options are shown. Contact SemiNex for additional details or to discuss your specific requirements.

High Power Laser Diode 4CM Module



Specification

4CM-204



Optical	Symbol	Typ.	Units
Center Wavelength	λ_c	1470	nm (± 20)
Output Power (CW)*	P_{out}	15	Watts ($\pm 10\%$)
Spectral Width FWHM	$\Delta\lambda$	20	nm
Slope Efficiency	η	1.4	W/A
Optical Fiber Core Dia.		400	μm
Optical Fiber NA		0.22	
Electrical	Symbol		Units
Power Conversion Eff.	η	22	%
Operating Current	I_{op}	13	A
Threshold Current	I_{TH}	1	A
Operating Voltage	V_{op}	5.4	V
Aiming Beam	Symbol		Units
Output Power	P_a	2	mW
Wavelength	λ_a	635	nm
Operating Current	I_{op}	50	mA
Voltage Limit	V_{max}	2.2	V
Mechanical			Units
Connector Type		SMA905	
Fiber Length		1.5	meters
Thermistor			
Thermistor Constant		3477	β
Thermistor Resistance		10	K ohm
		Range	
Operating Temp.**		-40 to 60	$^{\circ}\text{C}$
Storage Temp.		-40 to 80	$^{\circ}\text{C}$

*Specified values are rated at a constant heat sink temperature of 20°C.

**High temperature operation will reduce performance and MTTF.
Unless otherwise indicated all values are nominal.

*Detachable Fiber

Part Number	Description
4CMDf-204	4CM-204 with detachable fiber

High Power Laser Diode 4CM Module



SemiNex Laser Diodes 4CM-204

Graphs & Data

Typical 4CM L-I-V Characteristics

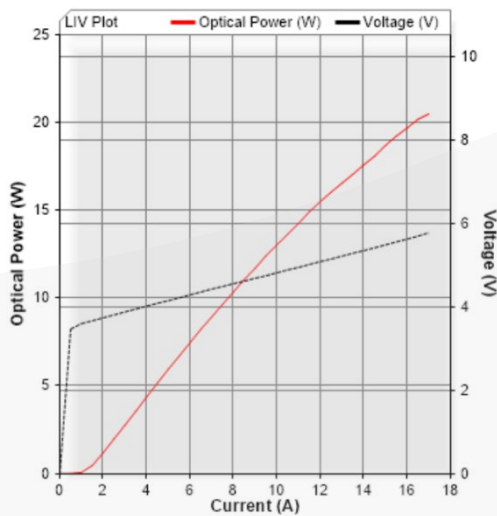
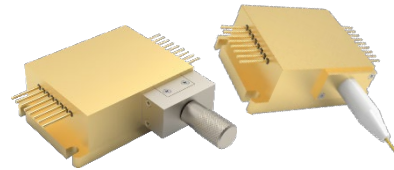

Typical 4CM Output Spectrum

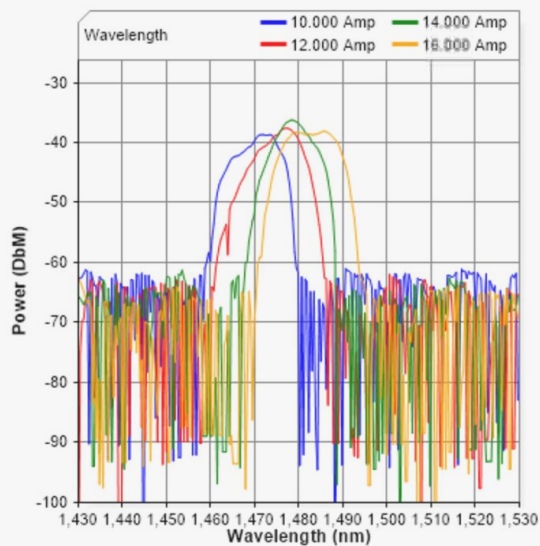

High Power Laser Diode 4CM Module



Mechanical Drawing Part Number: 4CM-204

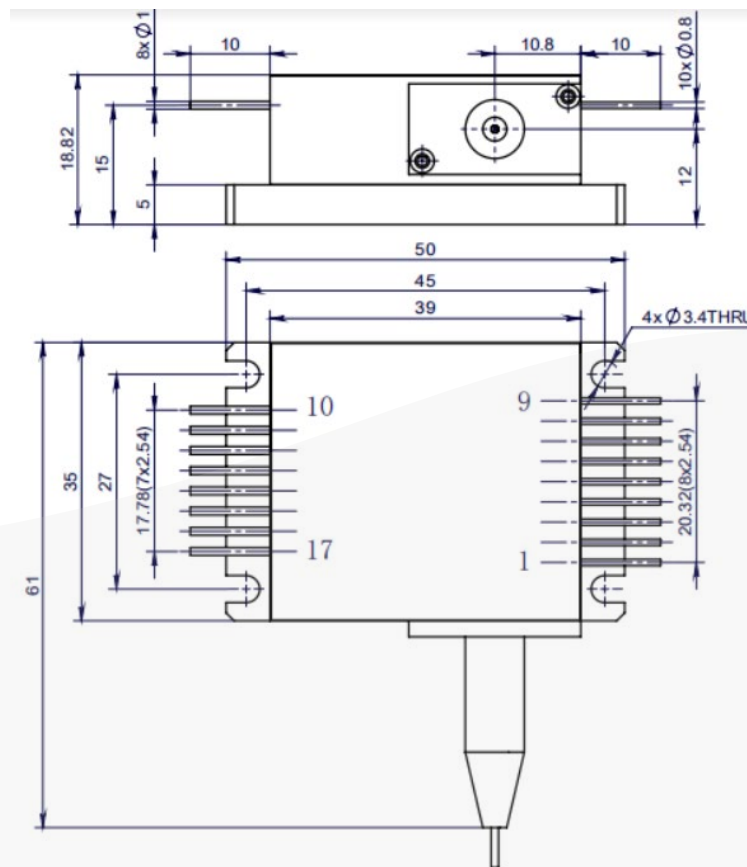
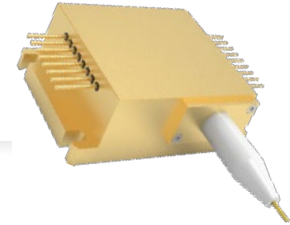

	4CM pin
PD (+)	#6
PD (-)	#7
Thermistor	#8
Thermistor	#9
LD (+)	#10
LD (-)	#15
Red Aiming Beam (+)	#16
Red Aiming Beam (-)	#17

All statements, technical information and recommendations related to the product herein are based upon information believed to be reliable or accurate. The accuracy or completeness herein is not guaranteed, and no responsibility is assumed for any inaccuracies. The user assumes all risks and liability whatsoever in connection with the use of a product or its application. SemiNex Corporation reserves the right to change at any time without notice the design, specification, deduction, fit or form of its described herein, including withdrawal at any time of a product offered for sale herein. Users are encouraged to visit www.seminex.com for the latest data. SemiNex Corporation makes no representations that the products herein are free from any intellectual property claims of others. Please contact SemiNex for more information. 2024 SemiNex Corporation



High Power Laser Diode 4CM Module



Mechanical Drawing Part Number: 4CMDF-204

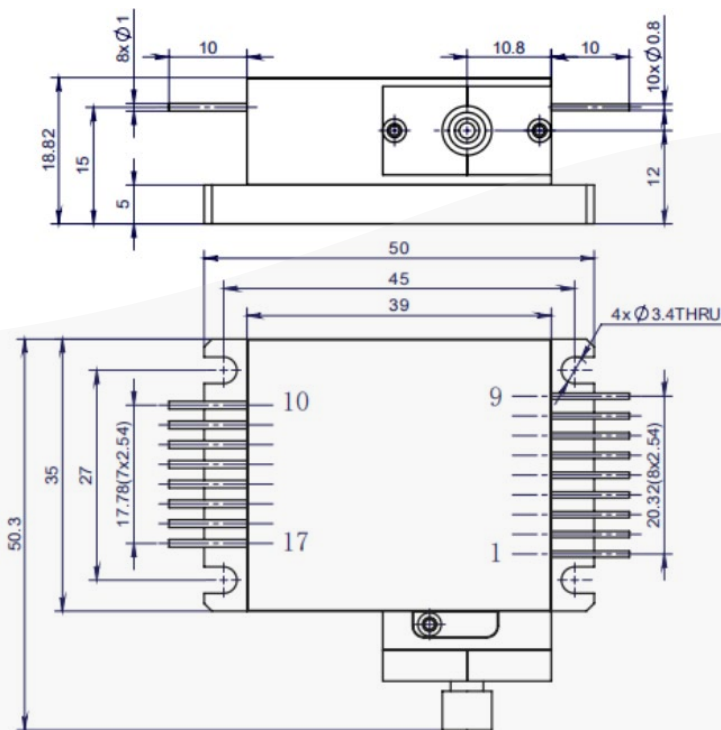
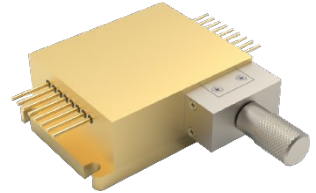

	4CM pin
PD (+)	#6
PD (-)	#7
Thermistor	#8
Thermistor	#9
LD (+)	#10
LD (-)	#15
Red Aiming Beam (+)	#16
Red Aiming Beam (-)	#17

All statements, technical information and recommendations related to the product herein are based upon information believed to be reliable or accurate. The accuracy or completeness herein is not guaranteed, and no responsibility is assumed for any inaccuracies. The user assumes all risks and liability whatsoever in connection with the use of a product or its application. SemiNex Corporation reserves the right to change at any time without notice the design, specification, deduction, fit or form of its described herein, including withdrawal at any time of a product offered for sale herein. Users are encouraged to visit www.seminex.com for the latest data. SemiNex Corporation makes no representations that the products herein are free from any intellectual property claims of others. Please contact SemiNex for more information. 2024 SemiNex Corporation

