

Duo-Lateral, Super Linear PSD's

Position Sensing Detectors (PSD)

The **Super Linear Position Sensors** feature state of the art duo-lateral technology to provide a continuous analog output proportional to the displacement of the centroid of a light spot from the center, on the active area. As continuous position sensors, these detectors are unparalleled; offering position accuracies of 99% over 64% of the sensing area. These accuracies are achieved by duo-lateral technology, manufacturing the detectors with two separate resistive layer, one located on the top and the other at the bottom of the chip. One or two dimensional position measurements can be obtained using these sensors. A reverse bias should be applied to these detectors to achieve optimum current linearity at high light levels.

The maximum recommended power density incident on the duo lateral PSDs are $1 \text{ mW} / \text{cm}^2$. For optimum performance, incident beam should be perpendicular to the active area with spot size less than 1mm in diameter.

APPLICATIONS

- Beam Alignment
- Position Sensing
- Angle Measurement
- Surface Profiling
- Height Measurements
- Targeting
- Guidance System
- Motion Analysis

FEATURES

- Super Linear
- Ultra High Accuracy
- Wide Dynamic Range
- High Reliability
- Duo Lateral Structure

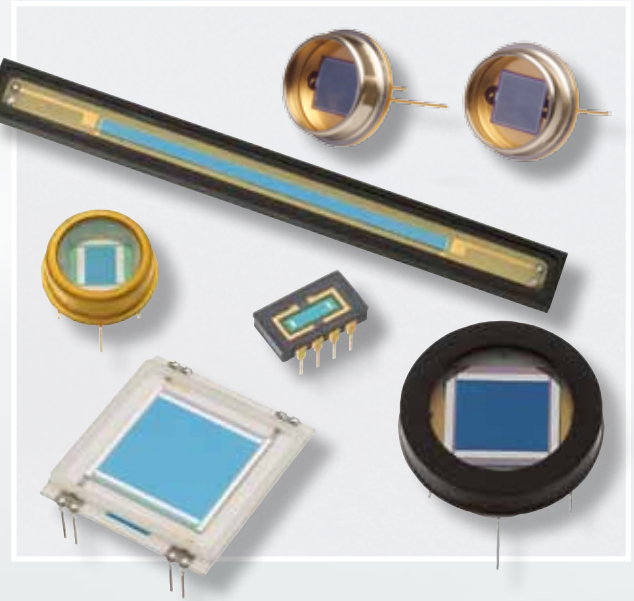

For position calculations and further details on circuit set up, refer to the "Photodiode Characteristics" section of the catalog.

Typical Position Detectability

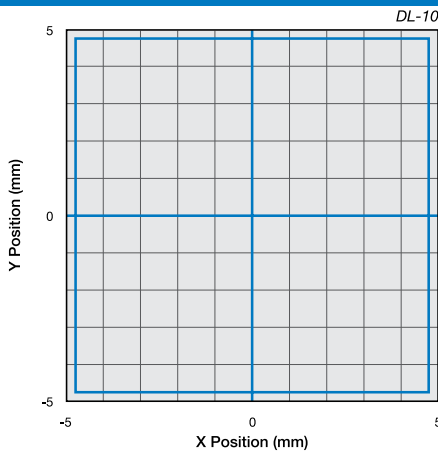

Typical Spectral Response

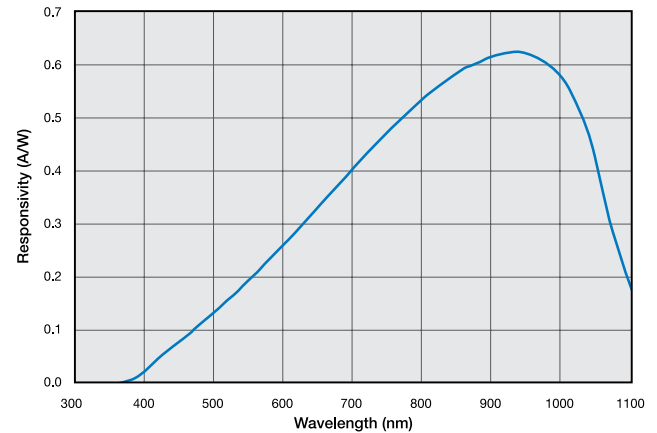

Typical Capacitance vs. Reverse Bias Voltage

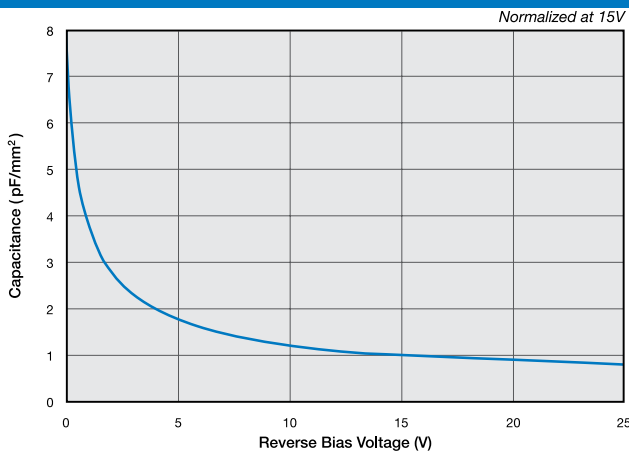

Typical Dark Current vs. Reverse Bias

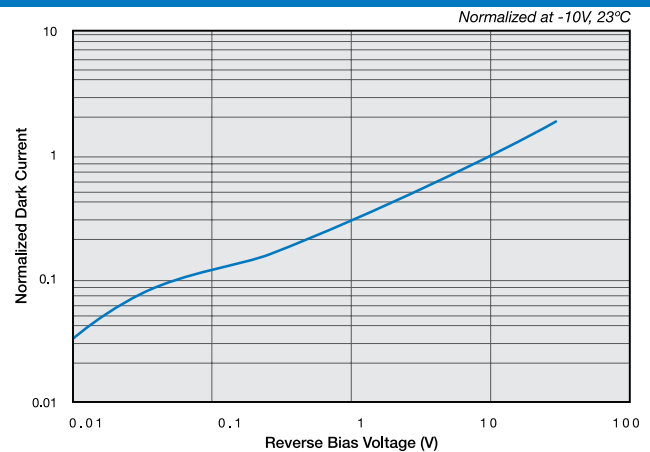

Duo-Lateral Super Linear PSD's

Typical Electro-Optical Specifications at $T_A=23^{\circ}\text{C}$

Model Number	Position Sensing Area		Responsivity (A/W)		Position Detection Error (μm)	Dark Current (nA)		Capacitance (pF)		Rise Time (μs)	Position Detection Drift † ($\mu\text{m} / ^{\circ}\text{C}$)	Inter-electrode Resistance (k Ω)		Temp Range ($^{\circ}\text{C}$)		Package Style ††
	Area (mm ²)	Dimension (mm)	670 nm		Over 80% of Length 64% of Sensing Area	-15 V, SL Series -5 V, DL Series		-15 V, SL Series -5 V, DL Series		670 nm 50 Ω		min.	max.	Operating	Storage	
			min.	typ.		typ.	typ.	max.	typ.							
One-Dimensional Series, Metal Package ($V_{\text{BIAS}}=-15\text{V}$)																
SL3-1	3	3 x 1	0.3	0.4	3	5	50	3	7	0.04	0.06	15	80	-10 ~ +60	-20 ~ +80	41 / TO-5
SL5-1	5	5 x 1			5	10	100	5	9	0.10	0.10	20	100			42 / TO-8
One-Dimensional Series, Ceramic Package ($V_{\text{BIAS}}=-15\text{V}$)																
SL3-2	3	3 x 1	0.3	0.4	3	5	50	3	7	0.04	0.06	15	80	-10 ~ +60	-20 ~ +80	48 / 8-pin DIP
SL5-2	5	5 x 1			5	10	100	5	9	0.10	0.10	20	100			
SL15	15	15 x 1			15	150	300	15	25	0.60	0.1	60	300			49 / 24-pin DIP
SL30	120	30 x 4			30	150	1000	125	150	1.0	0.6	40	80			51 / Ceramic
SL76-1	190	76 x 2.5			76	100	1000	190	250	14.0	1.4	120	600			50 / Special
Two-Dimensional Series, Metal Package § ($V_{\text{BIAS}}=-5\text{V}$)																
DL-2 «	4	2 sq	0.3	0.4	30	30	600	10	30	0.025	0.20	5	25	-10 ~ +60	-20 ~ +80	37 / TO-8
DLS-2 «						10	175	8	14		0.40					14 / TO-5
DLS-2S «						50	1000	35	60		0.25					37 / TO-8
DL-4	16	4 sq			25	300	30	40	0.30							
DLS-4					100	500	5000	175	375	0.20	0.60					34 / Special
DL-10	100	10 sq			200	2000	12000	600	1500	1.00	1.0					35 / Special
DL-20	400	20 sq														
Two-Dimensional Series, Ceramic Package § ($V_{\text{BIAS}}=-5\text{V}$)																
DLS-10	100	10 sq	0.3	0.4	100	50	400	160	200	0.20	0.70	5	25	-10 ~ +60	-20 ~ +80	36 / Ceramic
DLS-20	400	20 sq			200	100	1000	580	725	1.00	1.2					
Two-Dimensional Series, Low-Cost Ceramic Package ($V_{\text{BIAS}}=-5\text{V}$)																
DL-10C	100	10 sq	0.3	0.4	100	500	5000	175	375	0.20	0.60	5	25	-10 ~ +60	-20 ~ +80	38 / Ceramic
DL-20C	400	20 sq			200	2000	12000	600	1500	1.00	1.0					39 / Ceramic

† The position temperature drift specifications are for the die mounted on a copper plate without a window and the beam at the electrical center of the sensing area.

§ The DLS Series are packaged with A/R coated windows and have a lower dark current than the DL series.

†† For mechanical drawings please refer to pages 61 thru 73.

* Non-Condensing temperature and Storage Range, Non-Condensing Environment.

NOTES:

- DL(S) series are available with removable windows.
- Chip centering within $\pm 0.010"$.

« Minimum order quantities apply

AVOID DIRECT LIGHT

Since the spectral response of silicon photodiode includes the visible light region, care must be taken to avoid photodiode exposure to high ambient light levels, particularly from tungsten sources or sunlight. During shipment from OSI Optoelectronics, your photodiodes are packaged in opaque, padded containers to avoid ambient light exposure and damage due to shock from dropping or jarring.

AVOID SHARP PHYSICAL SHOCK

Photodiodes can be rendered inoperable if dropped or sharply jarred. The wire bonds are delicate and can become separated from the photodiode's bonding pads when the detector is dropped or otherwise receives a sharp physical blow.

CLEAN WINDOWS WITH OPTICAL GRADE CLOTH / TISSUE

Most windows on OSI Optoelectronics photodiodes are either silicon or quartz. They should be cleaned with isopropyl alcohol and a soft (optical grade) pad.

OBSERVE STORAGE TEMPERATURES AND HUMIDITY LEVELS

Photodiode exposure to extreme high or low storage temperatures can affect the subsequent performance of a silicon photodiode. Storage temperature guidelines are presented in the photodiode performance specifications of this catalog. Please maintain a non-condensing environment for optimum performance and lifetime.

OBSERVE ELECTROSTATIC DISCHARGE (ESD) PRECAUTIONS

OSI Optoelectronics photodiodes, especially with IC devices (e.g. Photops) are considered ESD sensitive. The photodiodes are shipped in ESD protective packaging. When unpacking and using these products, anti-ESD precautions should be observed.

DO NOT EXPOSE PHOTODIODES TO HARSH CHEMICALS

Photodiode packages and/or operation may be impaired if exposed to CHLOROTHENE, THINNER, ACETONE, or TRICHLOROETHYLENE.

INSTALL WITH CARE

Most photodiodes in this catalog are provided with wire or pin leads for installation in circuit boards or sockets. Observe the soldering temperatures and conditions specified below:

Soldering Iron:	Soldering 30 W or less Temperature at tip of iron 300°C or lower.
Dip Soldering:	Bath Temperature: 260±5°C. Immersion Time: within 5 Sec. Soldering Time: within 3 Sec.
Vapor Phase Soldering:	DO NOT USE
Reflow Soldering:	DO NOT USE

Photodiodes in plastic packages should be given special care. Clear plastic packages are more sensitive to environmental stress than those of black plastic. Storing devices in high humidity can present problems when soldering. Since the rapid heating during soldering stresses the wire bonds and can cause wire to bonding pad separation, it is recommended that devices in plastic packages to be baked for 24 hours at 85°C.

The leads on the photodiode **SHOULD NOT BE FORMED**. If your application requires lead spacing modification, please contact OSI Optoelectronics Applications group at (310)978-0516 before forming a product's leads. Product warranties could be voided.



Mechanical Drawings

Mechanical Specifications and Die Topography

1. Parameter Definitions:

A = Distance from top of chip to top of glass.

a = Photodiode Anode.

B = Distance from top of glass to bottom of case.

c = Photodiode Cathode

(Note: cathode is common to case in metal package products unless otherwise noted).

W = Window Diameter.

F.O.V. = Filed of View (see definition below).

2. Dimensions are in inches (1 inch = 25.4 mm).

3. Pin diameters are 0.018 ± 0.002 " unless otherwise specified.

4. Tolerances (unless otherwise noted)

General: $0.XX \pm 0.01$ "

$0.XXX \pm 0.005$ "

Chip Centering: ± 0.010 "

Dimension 'A': ± 0.015 "

5. Windows

All '**UV**' Enhanced products are provided with QUARTZ glass windows, 0.027 ± 0.002 " thick.

All '**XUV**' products are provided with removable windows.

All '**DLS**' PSD products are provided with A/R coated glass windows.

All '**FIL**' photoconductive and photovoltaic products are epoxy filled instead of glass windows.



$$F.O.V. = \tan^{-1} \left(\frac{W}{2A} \right)$$

For Further Assistance
Please Call One of Our Experienced
Sales and Applications Engineers

310-978-0516

OSI Optoelectronics
An OSI Systems Company

- Or -

visit our website at

www.osioptoelectronics.com

Mechanical Specifications

All units in inches. Pinouts are bottom view.

10 Low Profile

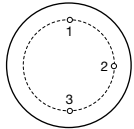
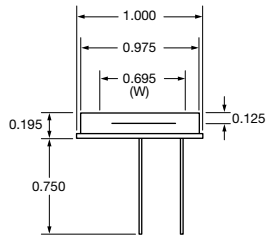

Pin Circle Dia.=0.73

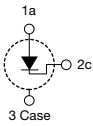

Products:

PIN-10DI
PIN-10DPI
PIN-10DPI/SB
UV-50L
UV-100L

11 BNC

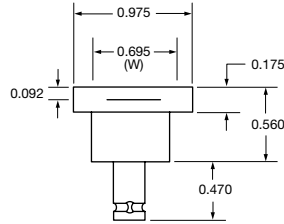

Outer Contact — Anode	PIN-10D, PIN-10DP, PIN-10DP/SB UV-100DQ, UV-100EQ
Outer Contact — Cathode	UV-50, UV-100

Products:

PIN-10D
PIN-10DP
PIN-10DP/SB
UV-50
UV-100
UV-100DQ
UV-100EQ

12 BNC

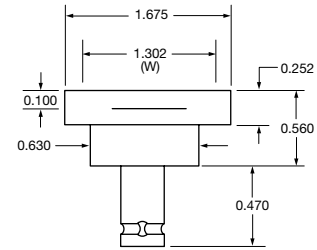

Outer Contact — Anode

Products:

PIN-25D
PIN-25DP

13 Special BNC

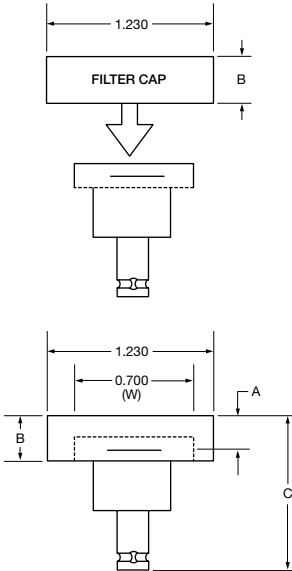

Dimensions			
P/N	A	B	C
PIN-10DF	0.217	0.330	1.020
PIN-10AP	0.386	0.550	1.415

Products:

PIN-10AP
PIN-10DF

14 TO-5

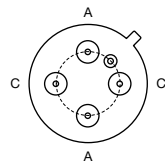
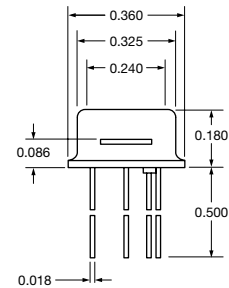

Pin Circle Dia.= 0.200
Bottom View

Products:

DLS-2S

15 Special Plastic

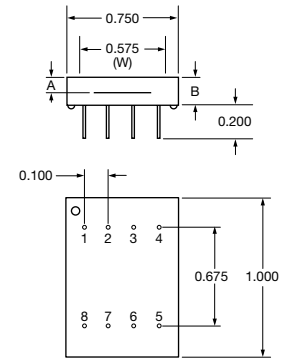

Dimensions

P/N	A	B
FIL-UV50	0.090	0.155

Pinouts

P/N	1	2	3	4	5	6	7	8
FIL-UV50	c	-	-	a	c	-	-	a

Mechanical Specifications

All units in inches. Pinouts are bottom view.

34 Special

Products:
DL-10

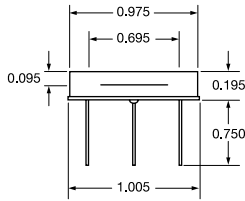

Pin Circle Dia.=0.730
Bottom View

Anode contacts are on the top of the detector.

35 Special

Products:
DL-20

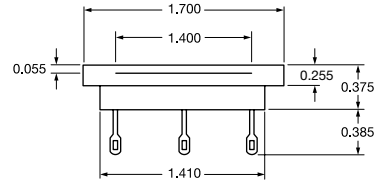

Pin Dia.=0.040
Pin Circle Dia.=1.110
Bottom View

Anode contacts are on the top of the detector.

36 Special Ceramic

Products:
DLS-10
DLS-20

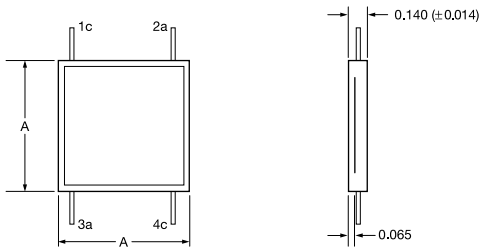

Pin Dia.=0.028 Typ.
Pin Length.=0.250 Typ.

P/N	A
DLS-10	1,000
DLS-20	1,500

37 TO-8

Products:
DL-2
DLS-2
DL-4
DLS-4

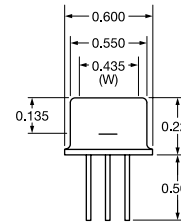

Pin Circle Dia.=0.400
Bottom View

38 Low Cost Ceramic

Products:
DL-10C

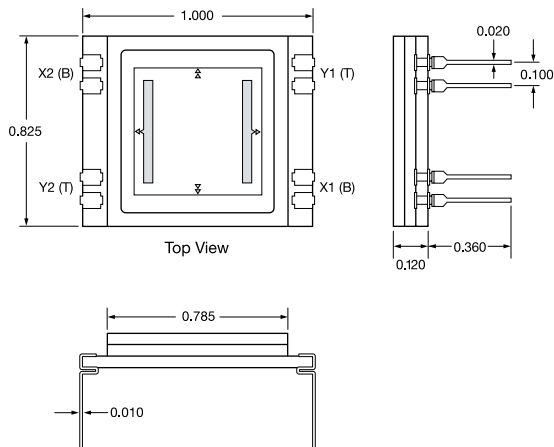

39 Low Cost Ceramic

Products:
DL-20C

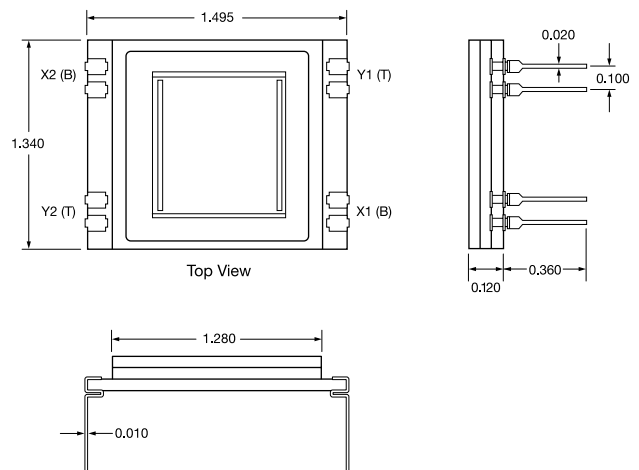

Mechanical Specifications

All units in inches. Pinouts are bottom view.

40 TO-18 41 TO-5 42 TO-8

Products:
SPOT-2DMI

Pin Circle Dia.=0.100

Products:
SC-4D
SL3-1
SPOT-2D
SPOT-3D
SPOT-4D
SPOT-4DMI
QD7-0

Pin Circle Dia.=0.200

Dimensions			
P/N	A	B	W
SC-4D	0.071	0.142	0.240
SL3-1	0.106	0.195	0.217
SPOT-2D	0.063	0.114	0.240
SPOT-3D	0.104	0.138	0.240
SPOT-4D	0.063	0.142	0.240
SPOT-4DMI	0.063	0.142	0.240
SPOT-4DUV	0.063	0.142	0.240
QD7-0	0.050	0.130	0.230

Pinouts					
P/N	1	2	3	4	5
SC-4D	c	c	c	c	a
SL3-1	a	c	a	--	--
SPOT-2D	a	c	a	--	--
SPOT-3D	a	c	a	--	--
SPOT-4D	a	a	a	a	c
SPOT-4DMI	a	a	a	a	c
SPOT-4DUV	a	a	a	a	c
QD7-0	a	a	a	a	c

Products:
SL5-1

Pin Circle Dia.=0.300

43 Low Profile

Products:
SPOT-9D
SPOT-9DMI

Pin Circle Dia.=0.730

44 Special

Products:
SC-10D

Pin Circle Dia.=0.730

45 Special

Products:
SC-25D

Pin Circle Dia.=0.950

Mechanical Specifications

All units in inches.

46 Plastic

Products:
LSC-30D

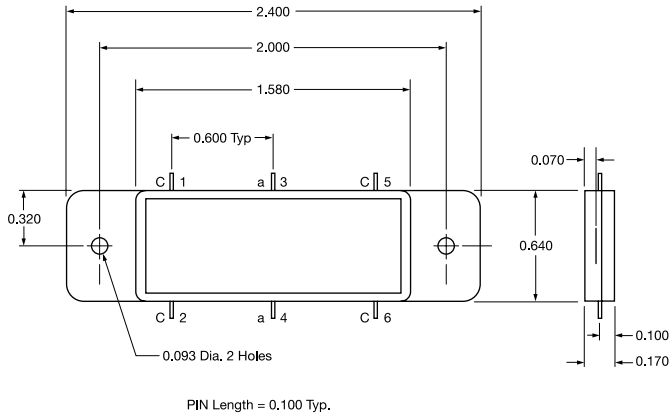

47 Plastic

Products:
LSC-5D

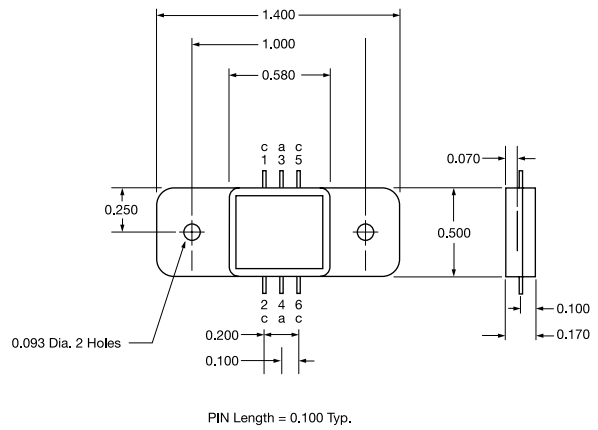

48 8-PIN DIP

Products:
SL3-2
SL5-2

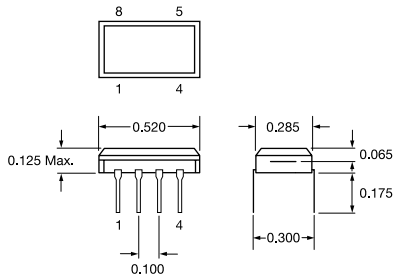

Pinouts

2, 7	Anode 1
1, 4, 5, 8	Common Cathode
3, 6	Anode 2

49 24-PIN DIP

Products:
SL-15

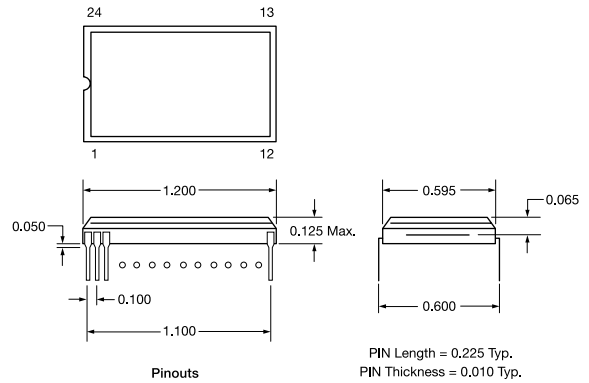

Pinouts

11	Anode 1
12, 24	Common Cathode
23	Anode 2
All Other Pins NOT CONNECTED	

50 Special

Products:
SL76-1

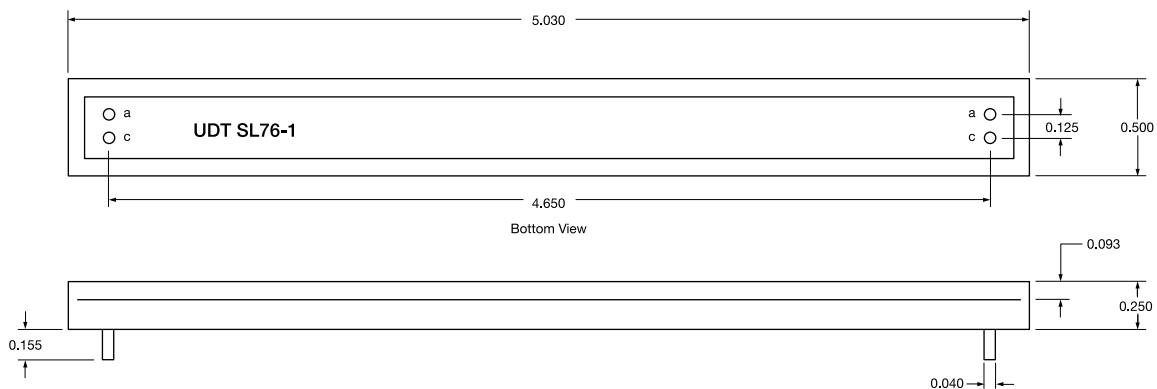

Mechanical Specifications

All units in inches. Pinouts are bottom view.

51 Low Cost Ceramic	52 Special	53 Special																					
<p>Products: SL-30</p>	<p>Products: A2V-76</p> <p>Pin Diameter = 0.025</p>	<p>Products: A2V-16</p> <table border="1"> <thead> <tr> <th colspan="7">Dimensions</th> </tr> <tr> <th>P/N</th> <th>A</th> <th>B</th> <th>C</th> <th>D</th> <th>E</th> <th>F</th> </tr> </thead> <tbody> <tr> <td>A2V-16</td> <td>1</td> <td>0.1</td> <td>0.212</td> <td>0.2</td> <td>0.062</td> <td>0.06</td> </tr> </tbody> </table>	Dimensions							P/N	A	B	C	D	E	F	A2V-16	1	0.1	0.212	0.2	0.062	0.06
Dimensions																							
P/N	A	B	C	D	E	F																	
A2V-16	1	0.1	0.212	0.2	0.062	0.06																	

54 40-PIN-DIP	55 Special																																																																																																																																																																								
<p>Products: A5V-35UV A5C-35, A5C-38 A5V-35, A5V-38</p>	<p>Products: A5V-35UV A5C-35 A5C-38 A5V-35 A5V-38 OSD100-0A OSD100-5TA</p>																																																																																																																																																																								
<p>35 Element Array</p> <table border="1"> <thead> <tr> <th>Pin Number</th> <th>Element Number</th> <th>Pin Number</th> <th>Element Number</th> </tr> </thead> <tbody> <tr><td>1</td><td>C</td><td>21</td><td>C</td></tr> <tr><td>2</td><td>2</td><td>22</td><td>35</td></tr> <tr><td>3</td><td>4</td><td>23</td><td>33</td></tr> <tr><td>4</td><td>6</td><td>24</td><td>31</td></tr> <tr><td>5</td><td>8</td><td>25</td><td>29</td></tr> <tr><td>6</td><td>10</td><td>26</td><td>27</td></tr> <tr><td>7</td><td>12</td><td>27</td><td>25</td></tr> <tr><td>8</td><td>14</td><td>28</td><td>23</td></tr> <tr><td>9</td><td>16</td><td>29</td><td>21</td></tr> <tr><td>10</td><td>18</td><td>30</td><td>19</td></tr> <tr><td>11</td><td>--</td><td>31</td><td>17</td></tr> <tr><td>12</td><td>20</td><td>32</td><td>15</td></tr> <tr><td>13</td><td>22</td><td>33</td><td>13</td></tr> <tr><td>14</td><td>24</td><td>34</td><td>11</td></tr> <tr><td>15</td><td>26</td><td>35</td><td>9</td></tr> <tr><td>16</td><td>28</td><td>36</td><td>7</td></tr> <tr><td>17</td><td>30</td><td>37</td><td>5</td></tr> <tr><td>18</td><td>32</td><td>38</td><td>3</td></tr> <tr><td>19</td><td>34</td><td>39</td><td>1</td></tr> <tr><td>20</td><td>C</td><td>40</td><td>C</td></tr> </tbody> </table>	Pin Number	Element Number	Pin Number	Element Number	1	C	21	C	2	2	22	35	3	4	23	33	4	6	24	31	5	8	25	29	6	10	26	27	7	12	27	25	8	14	28	23	9	16	29	21	10	18	30	19	11	--	31	17	12	20	32	15	13	22	33	13	14	24	34	11	15	26	35	9	16	28	36	7	17	30	37	5	18	32	38	3	19	34	39	1	20	C	40	C	<p>38 Element Array</p> <table border="1"> <thead> <tr> <th>Pin Number</th> <th>Element Number</th> <th>Pin Number</th> <th>Element Number</th> </tr> </thead> <tbody> <tr><td>1</td><td>C</td><td>21</td><td>C</td></tr> <tr><td>2</td><td>2</td><td>22</td><td>37</td></tr> <tr><td>3</td><td>4</td><td>23</td><td>35</td></tr> <tr><td>4</td><td>6</td><td>24</td><td>33</td></tr> <tr><td>5</td><td>8</td><td>25</td><td>31</td></tr> <tr><td>6</td><td>10</td><td>26</td><td>29</td></tr> <tr><td>7</td><td>12</td><td>27</td><td>27</td></tr> <tr><td>8</td><td>14</td><td>28</td><td>25</td></tr> <tr><td>9</td><td>16</td><td>29</td><td>23</td></tr> <tr><td>10</td><td>18</td><td>30</td><td>21</td></tr> <tr><td>11</td><td>20</td><td>31</td><td>19</td></tr> <tr><td>12</td><td>22</td><td>32</td><td>17</td></tr> <tr><td>13</td><td>24</td><td>33</td><td>15</td></tr> <tr><td>14</td><td>26</td><td>34</td><td>13</td></tr> <tr><td>15</td><td>28</td><td>35</td><td>11</td></tr> <tr><td>16</td><td>30</td><td>36</td><td>9</td></tr> <tr><td>17</td><td>32</td><td>37</td><td>7</td></tr> <tr><td>18</td><td>34</td><td>38</td><td>5</td></tr> <tr><td>19</td><td>36</td><td>39</td><td>3</td></tr> <tr><td>20</td><td>38</td><td>40</td><td>1</td></tr> </tbody> </table>	Pin Number	Element Number	Pin Number	Element Number	1	C	21	C	2	2	22	37	3	4	23	35	4	6	24	33	5	8	25	31	6	10	26	29	7	12	27	27	8	14	28	25	9	16	29	23	10	18	30	21	11	20	31	19	12	22	32	17	13	24	33	15	14	26	34	13	15	28	35	11	16	30	36	9	17	32	37	7	18	34	38	5	19	36	39	3	20	38	40	1
Pin Number	Element Number	Pin Number	Element Number																																																																																																																																																																						
1	C	21	C																																																																																																																																																																						
2	2	22	35																																																																																																																																																																						
3	4	23	33																																																																																																																																																																						
4	6	24	31																																																																																																																																																																						
5	8	25	29																																																																																																																																																																						
6	10	26	27																																																																																																																																																																						
7	12	27	25																																																																																																																																																																						
8	14	28	23																																																																																																																																																																						
9	16	29	21																																																																																																																																																																						
10	18	30	19																																																																																																																																																																						
11	--	31	17																																																																																																																																																																						
12	20	32	15																																																																																																																																																																						
13	22	33	13																																																																																																																																																																						
14	24	34	11																																																																																																																																																																						
15	26	35	9																																																																																																																																																																						
16	28	36	7																																																																																																																																																																						
17	30	37	5																																																																																																																																																																						
18	32	38	3																																																																																																																																																																						
19	34	39	1																																																																																																																																																																						
20	C	40	C																																																																																																																																																																						
Pin Number	Element Number	Pin Number	Element Number																																																																																																																																																																						
1	C	21	C																																																																																																																																																																						
2	2	22	37																																																																																																																																																																						
3	4	23	35																																																																																																																																																																						
4	6	24	33																																																																																																																																																																						
5	8	25	31																																																																																																																																																																						
6	10	26	29																																																																																																																																																																						
7	12	27	27																																																																																																																																																																						
8	14	28	25																																																																																																																																																																						
9	16	29	23																																																																																																																																																																						
10	18	30	21																																																																																																																																																																						
11	20	31	19																																																																																																																																																																						
12	22	32	17																																																																																																																																																																						
13	24	33	15																																																																																																																																																																						
14	26	34	13																																																																																																																																																																						
15	28	35	11																																																																																																																																																																						
16	30	36	9																																																																																																																																																																						
17	32	37	7																																																																																																																																																																						
18	34	38	5																																																																																																																																																																						
19	36	39	3																																																																																																																																																																						
20	38	40	1																																																																																																																																																																						