

Features

- $\varnothing 800 \mu\text{m}$ active area
- High QE for $\lambda = 850\text{-}1064 \text{ nm}$
- Low noise
- Low slope multiplication curve

Description

Circular active area APD chip with IR enhanced sensitivity. Very low dark current due to guard ring diode. Metal can type hermetic TO5i package with clear glass window.

Application

- Pulsed 1064 nm laser detection
- Laser range finding
- Fluorescence detection

RoHS

2002/95/EC



Absolute maximum ratings

Symbol	Parameter	Min	Max	Unit
T_{STG}	Storage temp	-55	125	$^{\circ}\text{C}$
T_{OP}	Operating temp	-15	70	$^{\circ}\text{C}$
M_{max}	Gain ($I_{PO} = 1 \text{ nA}$)	1000		
I_{PEAK}	Peak DC current		0.25	mA

Spectral response ($M = 100$; $23 \text{ }^{\circ}\text{C}$)

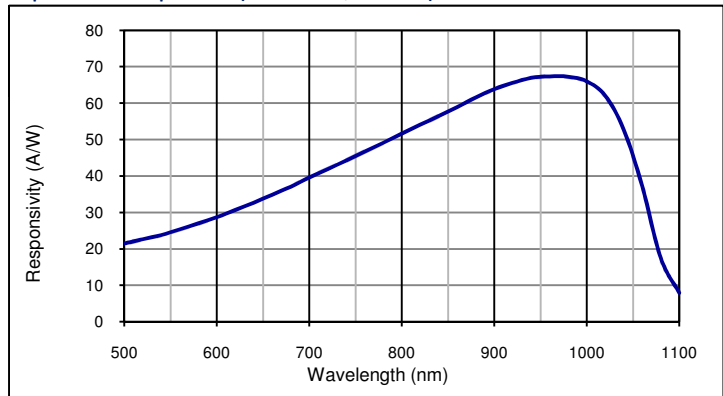

Schematic

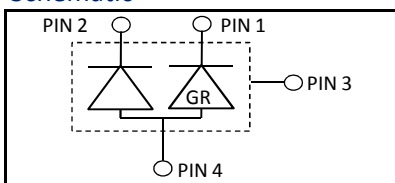

Electro-optical characteristics @ $23 \text{ }^{\circ}\text{C}$

Symbol	Characteristic	Test Condition	Min	Typ	Max	Unit
	Active area			$\varnothing 800$		μm
	Active area			0.5		mm^2
I_D	Dark current	$M = 100$		3	25	nA
C	Capacitance	$M = 100$		1		pF
	Responsivity	$M = 100$; $\lambda = 905 \text{ nm}$		65		A/W
	Responsivity	$M = 100$; $\lambda = 1064 \text{ nm}$		36		A/W
t_R	Rise time	$M = 100$; $\lambda = 1064 \text{ nm}$; $R_i = 50 \Omega$		5		ns
t_R	Cut-off frequency	-3dB		70		MHz
V_{BR}	Breakdown voltage	$I_R = 2 \mu\text{A}$	220	300	600	V
	Temperature coefficient			3.3		V/K

European, International Sales:



First Sensor AG
 Peter-Behrens-Strasse 15
 12459 Berlin
 Germany
 Phone: +49-30-6399-2399
 Fax: +49-30-6399-23752
 E-Mail: sales.opto@first-sensor.com

USA:



Pacific Silicon Sensor, Inc.
 5700 Corsa Avenue #105
 Westlake Village
 CA 91362 USA
 Phone: +1-818-706-3400
 Fax: +1-818-889-7053
 E-Mail: sales@pacific-sensor.com



Quantum efficiency (23 °C)

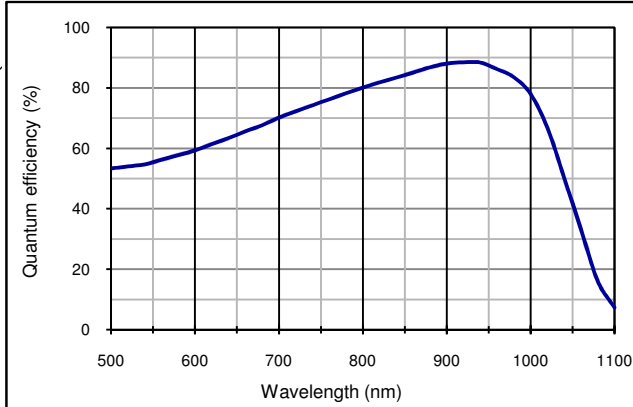

Capacitance as fct of reverse bias (23 °C)

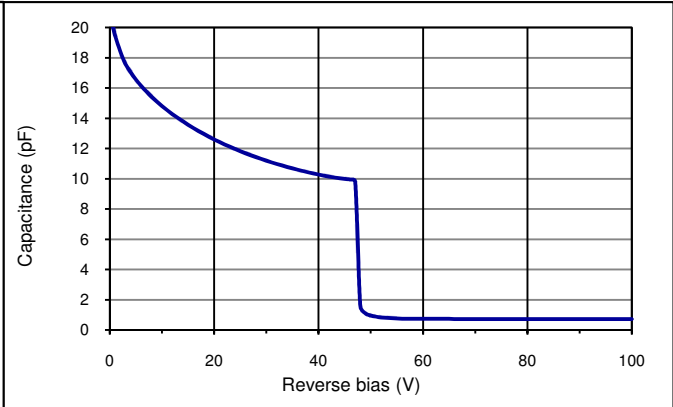

Multiplication as fct of reverse bias

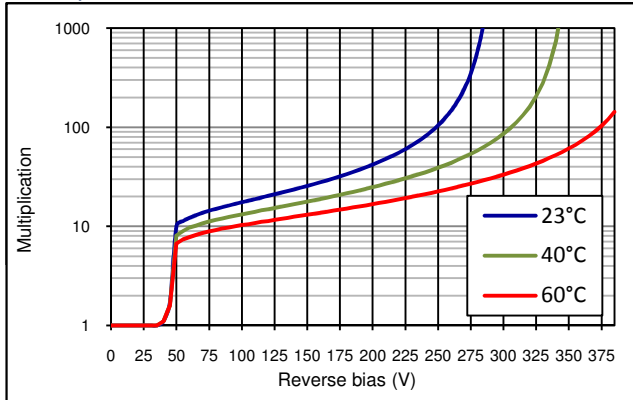

Dark current as fct of reverse bias

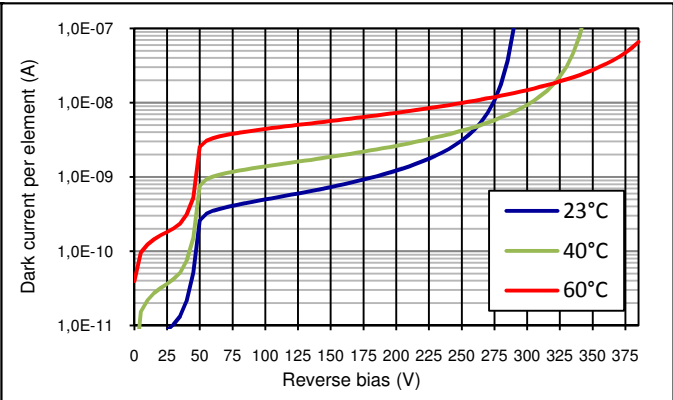

Application hints:

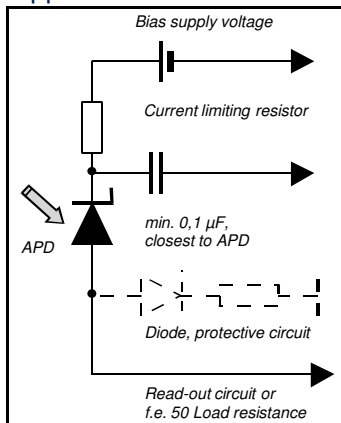

- Current should be limited by a protecting resistor or current limiting - IC inside the power supply
- For low light level applications blocking of ambient light should be used
- For high gain applications bias voltage should be temperature compensated
- Please consider basic ESD protection while handling
- Use low noise read-out - IC
- For further questions please refer to document "Instructions for handling and processing"

Package dimension:

Small quantities: Foam pad, boxed (12 cm x 16.5 cm)

Disclaimer: Due to our strive for continuous improvement, specifications are subject to change within our PCN policy according to JESD46C.

European, International Sales:



First Sensor AG
 Peter-Behrens-Strasse 15
 12459 Berlin
 Germany
 Phone: +49-30-6399-2399
 Fax: +49-30-6399-23752
 E-Mail: sales.opto@first-sensor.com

USA:



Pacific Silicon Sensor, Inc.
 5700 Corsa Avenue #105
 Westlake Village
 CA 91362 USA
 Phone: +1-818-706-3400
 Fax: +1-818-889-7053
 E-Mail: sales@pacific-sensor.com