

High Power Laser Diode Fiber Coupled TO9

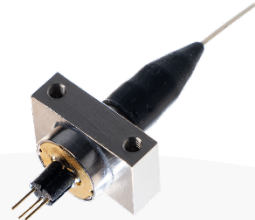

Part Number: TO9F-104

High Power TO9 Fiber Coupled Module
Single-Mode Fabry-Perot Laser Diode
Wavelength at 1565nm



Features

- High Output Power
- High Dynamic Range
- High Efficiency
- TO9 Fiber Coupled Module
- Cost Effective

Application

- Professional Medical
- Home Use Medical
- Laser Range Finder
- Target Illumination
- Telecom OTDR



SemiNex delivers the highest available power at infrared wavelengths between 12xx and 19xx nm. When necessary, we will further optimize the design of our InP & GaSb laser chips to meet our customers' specific optical and electrical performance needs. Diodes, bars and packages are tested to meet customer and market performance demands. Typical results and packaging options are shown. Contact SemiNex for additional details or to discuss your specific requirements.

High Power Laser Diode Fiber Coupled TO9



Specification

TO9F-104

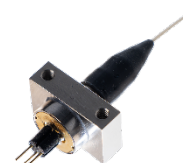

Optical	Symbol	Typ.	Units
Center Wavelength	λ_c	1565	nm (± 20)
Output Power (CW)*	P_{out}	0.14	watts ($\pm 10\%$)
Spectral Width FWHM	$\Delta\lambda$	10	nm
Slope Efficiency	η	0.18	W/A
Optical Fiber Core Dia.		9	μm
Optical Fiber NA		SMF	
Electrical	Symbol		Units
Power Conversion Eff.	η	8	%
Operating Current	I_{op}	1	A
Threshold Current	I_{TH}	0.07	A
Operating Voltage	V_{op}	2	V
Mechanical	Symbol		Units
Fiber Length		1	meters
Connector Type		FC/PC	
		Range	
Operating Temp.**		-40 to 60	$^{\circ}\text{C}$
Storage Temp.		-40 to 80	$^{\circ}\text{C}$

PLEASE NOTE: The TO9F laser package is not electrically isolated. The package body is the anode connection. Care should be taken in mounting and installation.
 *Specified values are rated at a constant heat sink temperature of 20°C.
 **High temperature operation will reduce performance and MTTF.
 Unless otherwise indicated all values are nominal.

High Power Laser Diode Fiber Coupled TO9



SemiNex Laser Diodes TO9F-104

Graphs & Data

Typical TO9F L-I-V Characteristics

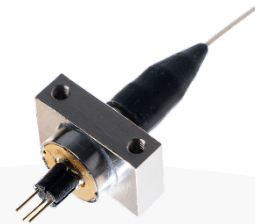
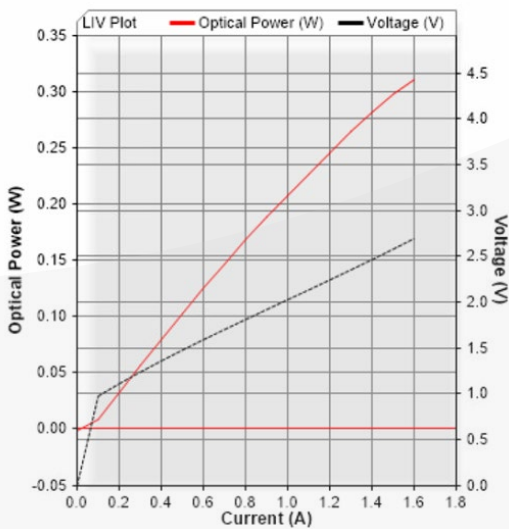

Typical TO9F Output Spectrum

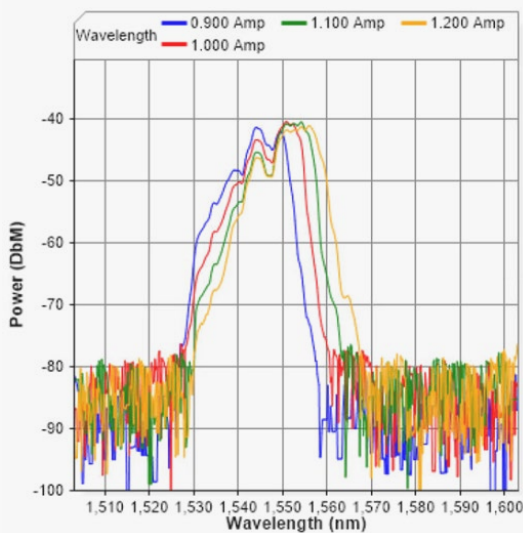

High Power Laser Diode Fiber Coupled TO9



Mechanical Drawing

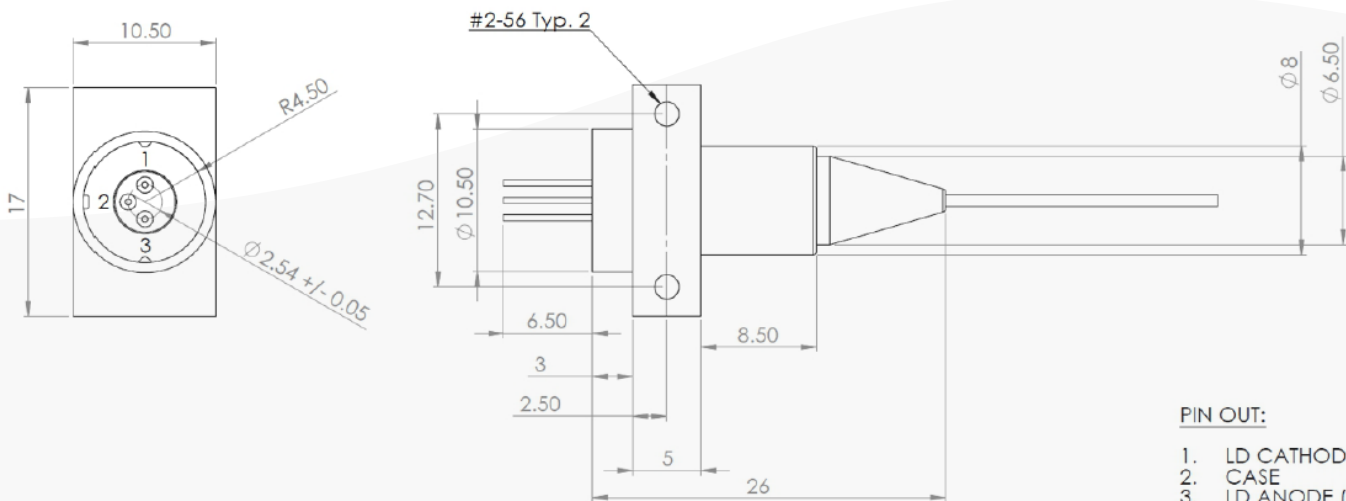
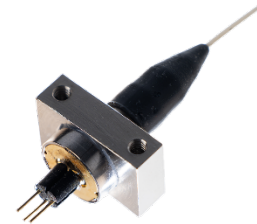

PIN OUT:

1. LD CATHODE (-)
2. CASE
3. LD ANODE (+)

All statements, technical information and recommendations related to the product herein are based upon information believed to be reliable or accurate. The accuracy or completeness herein is not guaranteed, and no responsibility is assumed for any inaccuracies. The user assumes all risks and liability whatsoever in connection with the use of a product or its application. SemiNex Corporation reserves the right to change at any time without notice the design, specification, deduction, fit or form of its described herein, including withdrawal at any time of a product offered for sale herein. Users are encouraged to visit www.seminex.com for the latest data. SemiNex Corporation makes no representations that the products herein are free from any intellectual property claims of others. Please contact SemiNex for more information. 2024 SemiNex Corporation

