

Features

- APD with 0.04 mm² active area
- Slow multiplication curve
- QE > 80% @ 750 nm-910 nm
- Fast rise time, low noise
- Optimum gain: 50-60

Description

Circular active area APD chip with NIR enhanced sensitivity. Metal can type hermetic TO52 package with 905nm BP filter.

Application

- Laser range finder
- High speed photometry
- High speed optical communications
- Medical equipment

RoHS

2011/65/EU

Absolute maximum ratings

Symbol	Parameter	Min	Max	Unit
T _{STG}	Storage temp	-55	125	°C
T _{OP}	Operating temp	-40	100	°C
M _{max}	Gain (I _{PO} = 1 nA)	200		
I _{PEAK}	Peak DC current		0.25	mA

Spectral response (M = 100)

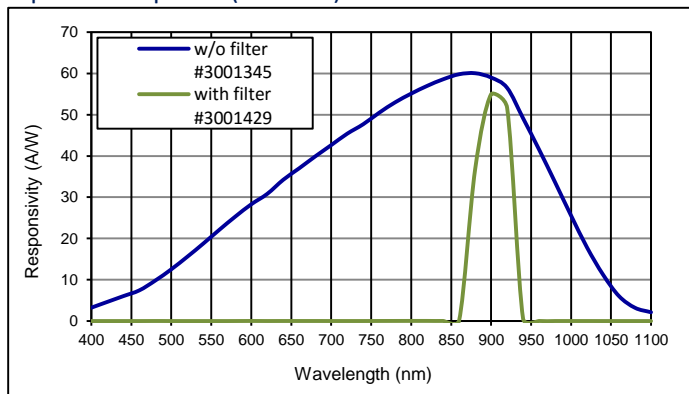

Schematic

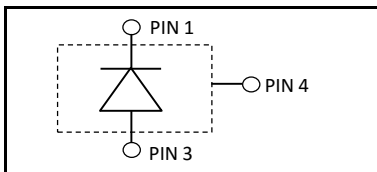

Electro-optical characteristics @ 23 °C

Symbol	Characteristic	Test Condition	Min	Typ	Max	Unit
	Active area		diameter 230			µm
	Active area		0.04			mm ²
I _D	Dark current	M = 100		0.5	1	nA
C	Capacitance	M = 100		0.3		pF
	Responsivity with filter	M = 100; λ = 905 nm	42	55		A/W
t _R	Rise time	M = 100; λ = 905 nm; R _L = 50 Ω		0.5		ns
	Cut-off frequency	-3dB		0.6		GHz
V _{BR}	Breakdown voltage	I _R = 2 µA	160		200	V
	Temperature coefficient	Change of V _{BR} with temperature	1.25		1.55	V/K
	Excess noise factor	M = 100		2.5		
	Excess noise index	M = 100		0.2		

Quantum efficiency (23 °C)

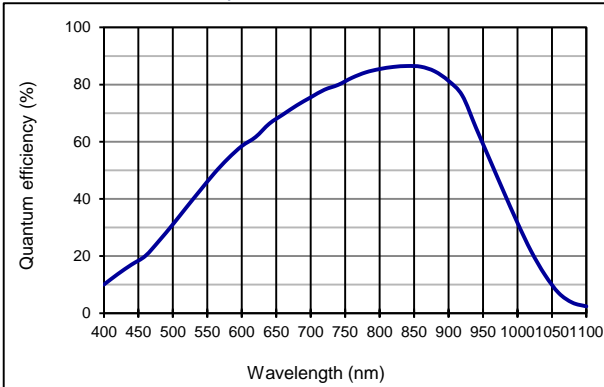

Capacitance as fct of reverse bias (23 °C)

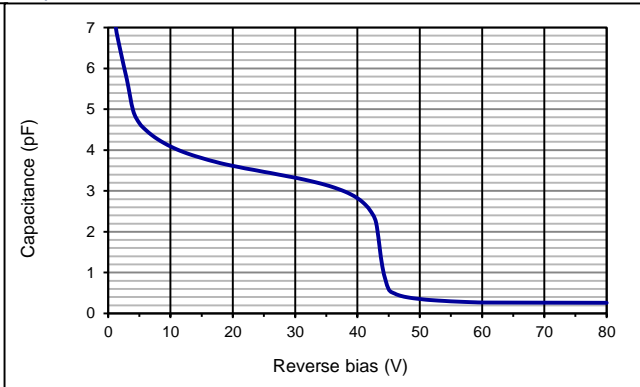

Multiplication as fct of bias (23 °C)

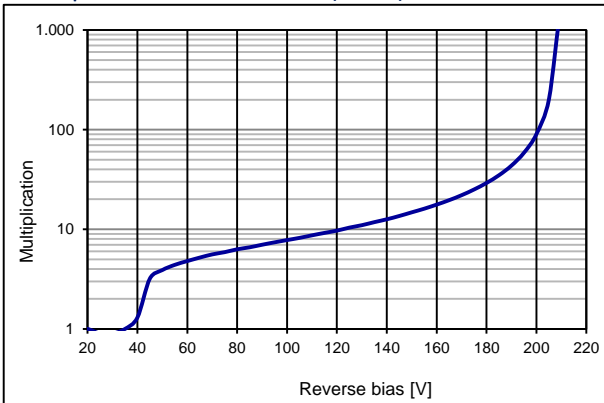

Dark current as fct of bias (23 °C)

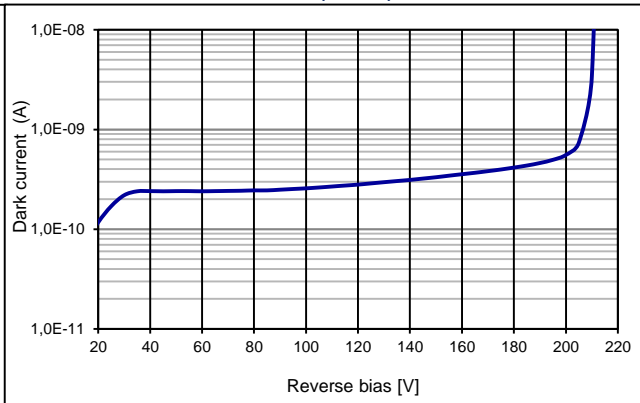

Filter characteristics 905 nm band pass

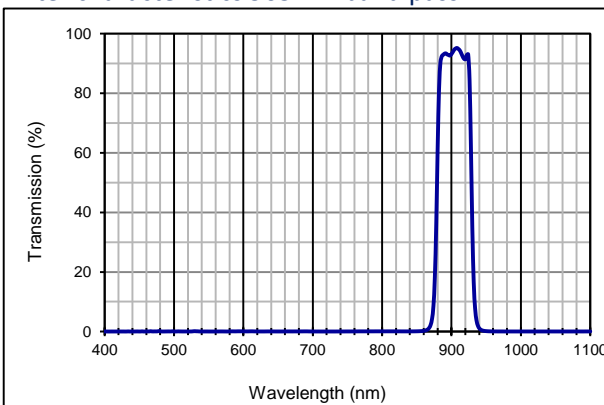

Application hints*:

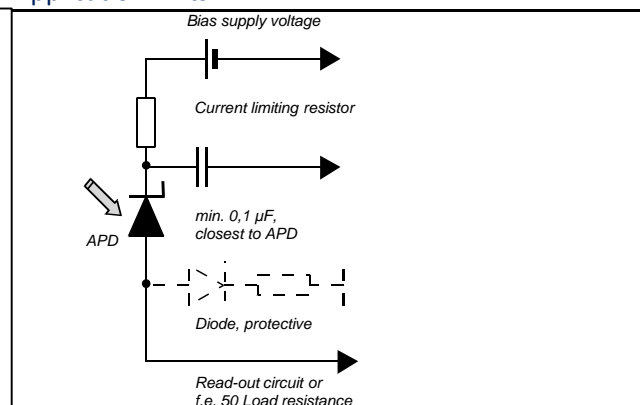

- * • Current should be limited by a protecting resistor or current limiting - IC inside the power supply
- For low light level applications blocking of ambient light should be used
- For high gain applications bias voltage should be temperature compensated
- Please consider basic ESD protection while handling
- Use low noise read-out - IC
- For further questions please refer to document "Instructions for handling and processing"

Technical Drawing, Package: TO52S1F2

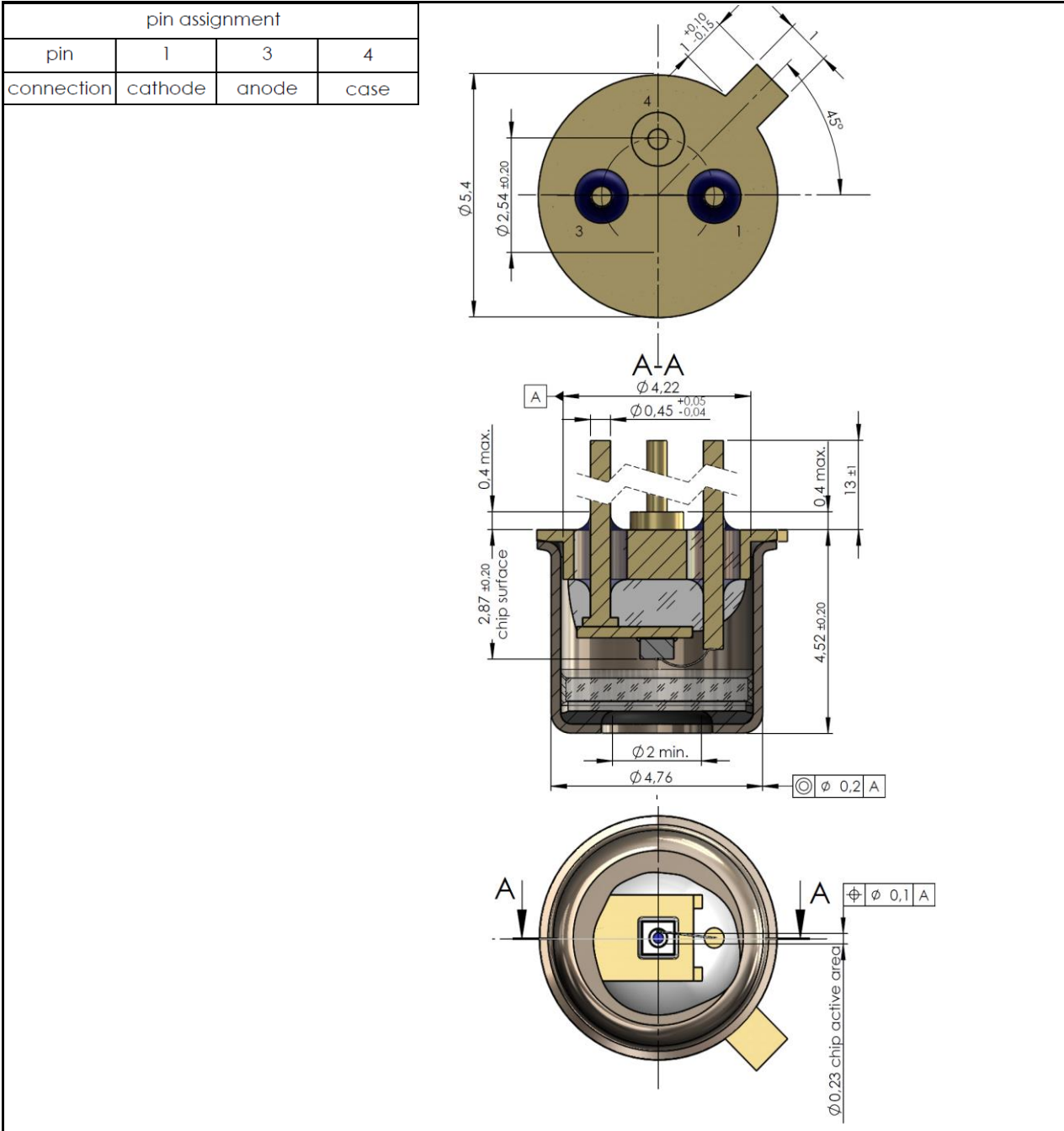

Package dimension:

Small quantities: Foam pad, boxed (12 cm x 16.5 cm)

Disclaimer: Due to our strive for continuous improvement, specifications are subject to change within our PCN policy according to JESD46C.